

Sleek Shields™ MULTI-USE FOOD SHIELDS WITH STAINLESS STEEL SHELF

**Quickly Converts From Cafeteria Style
To Self Serve Style**

Item #: _____ Qty #: _____
Model #: _____
Project #: _____



FEATURES:

- Bottom front glass locks in place at 3 fixed positions
- Entire glass front rotates for easy cleaning
- Stainless steel 1" diameter Posts
- Includes Two 18" Wide Glass Side Panels
- 1/4" Thick Heat-Tempered Glass Side Panels
- 3/8" Thick Heat-Tempered Glass Fronts
- Stainless Steel Top Shelf

CONSTRUCTION:

All TIG welded
Exposed stainless steel surfaces polished to a satin finish

MATERIAL:

18 Ga., Type 430 Stainless Steel shelf
1/4" Thick Heat-Tempered Side Glass
3/8" Thick Heat-Tempered Glass Fronts
1" Posts - Stainless Steel
Chamber Lock™ Sleek Shield Assemblies - Anodized Aluminum.
Finish - Aluminum components are anodized to a satin finish.
Stainless components polished.

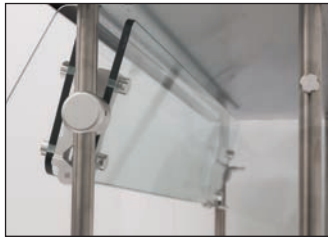

Bottom Glass Flips All The Way Up To Become A Self-Serve Unit

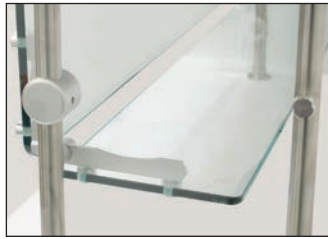

Bottom Glass Can be Used As a Shelf

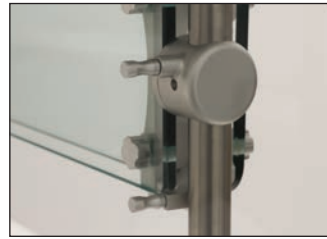

Easy To Use Mechanism For Changing Front Glass Positions

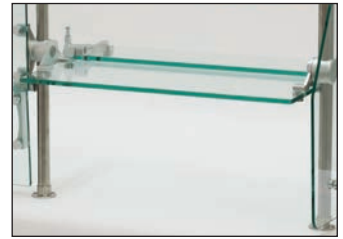

Entire Glass Shield Rotates For Easy Cleaning

L	12" WIDE	Approx. Wt.	15" WIDE	Approx. Wt.	18" WIDE	Approx. Wt.	Approx. Cubes
36"	DSG-12S-36	131 lbs.	DSG-15S-36	133 lbs.	DSG-18S-36	136 lbs.	18
48"	DSG-12S-48	166 lbs.	DSG-15S-48	169 lbs.	DSG-18S-48	173 lbs.	23
60"	DSG-12S-60	191 lbs.	DSG-15S-60	196 lbs.	DSG-18S-60	199 lbs.	29
72"	DSG-12S-72	237 lbs.	DSG-15S-72	245 lbs.	DSG-18S-72	250 lbs.	34
84"	DSG-12S-84†	276 lbs.	DSG-15S-84†	279 lbs.	DSG-18S-84†	286 lbs.	39
96"	DSG-12S-96†	312 lbs.	DSG-15S-96†	314 lbs.	DSG-18S-96†	323 lbs.	44
108"	DSG-12S-108†	346 lbs.	DSG-15S-108†	353 lbs.	DSG-18S-108†	359 lbs.	49
120"	DSG-12S-120†	382 lbs.	DSG-15S-120†	389 lbs.	DSG-18S-120†	397 lbs.	55
132"	DSG-12S-132†	420 lbs.	DSG-15S-132†	428 lbs.	DSG-18S-132†	437 lbs.	60
144"	DSG-12S-144††	455 lbs.	DSG-15S-144††	465 lbs.	DSG-18S-144††	473 lbs.	65

† Requires a single pair of center legs †† Requires two pairs of center legs

DETAILS and SPECIFICATIONS

TOL ± .500"

ALL DIMENSIONS ARE TYPICAL

DSG-S SERIES - STAINLESS STEEL SHELF

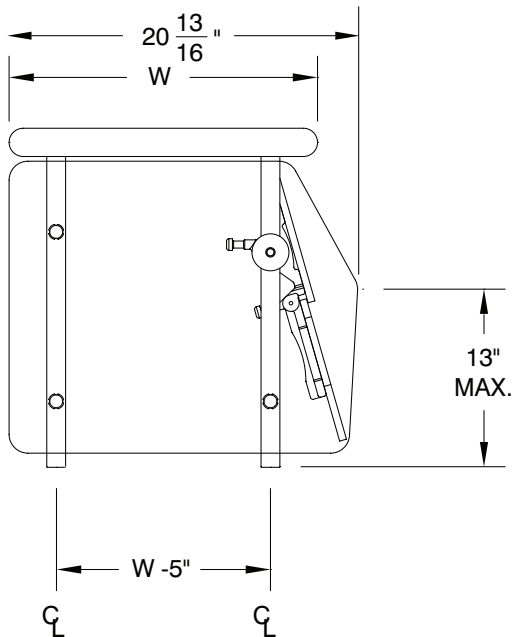

Standard Concealed Mounting Hardware

Requires access below counter for installation.

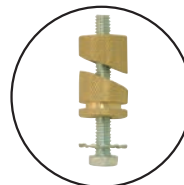
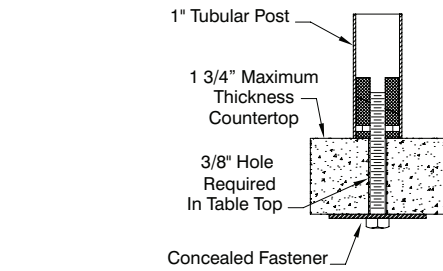

Brass Expander Table Mounting Hardware Included.
For traditional undermount installation (1" tubing only)

