



STAINLESS STEEL
**CEILING MOUNTED
 SHELVING**



SINGLE SHELF



DOUBLE SHELVES

Item #: _____ Qty #: _____
 Model #: _____
 Project #: _____

FEATURES:

18" wide fully adjustable shelving.
 Shipped KD.
 Load Capacity is 5 lbs. per sq. ft. (Evenly Distributed).

CONSTRUCTION:

All TIG welded.
 Exposed surfaces polished to a satin finish.

MATERIAL:

All Shelves are 18 gauge type "430" stainless steel.
 1 5/8" stainless steel tubular support posts.

CUSTOMER MUST PROVIDE PRINT

SINGLE SHELF	Wt.	DOUBLE SHELVES	Wt.	Width	(L) Length
CM-18-36	24 lbs.	DCM-18-36	55 lbs.	18"	36"
CM-18-48	29 lbs.	DCM-18-48	60 lbs.	18"	48"
CM-18-60	35 lbs.	DCM-18-60	66 lbs.	18"	60"
CM-18-72	40 lbs.	DCM-18-72	72 lbs.	18"	72"
CM-18-84	46 lbs.	DCM-18-84	78 lbs.	18"	84"
CM-18-96*	51 lbs.	DCM-18-96*	84 lbs.	18"	96"

*96" Units Provided With 3 Support Posts

Custom Sizes are Available.
 Contact Our **SMART FABRICATION™** Department.
 800-498-6634



Customer Service Available To Assist You 1-800-645-3166 8:30 am - 8:00 pm E.S.T.

For Orders & Customer Service:
 Email: customer@advancetabco.com or Fax: 631-242-6900

For Smart Fabrication™ Quotes:
 Email: smartfab@advancetabco.com or Fax: 631-586-2933

DETAILS and SPECIFICATIONS

TOL ± .500"

ALL DIMENSIONS ARE TYPICAL

SINGLE SHELF

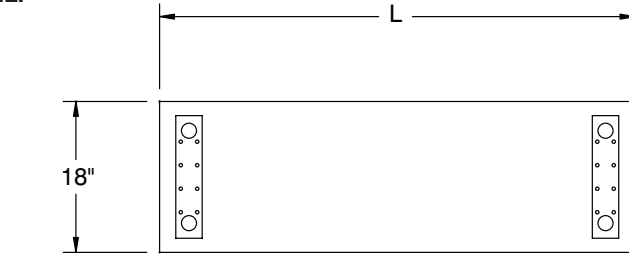

CUSTOMER MUST PROVIDE PRINT

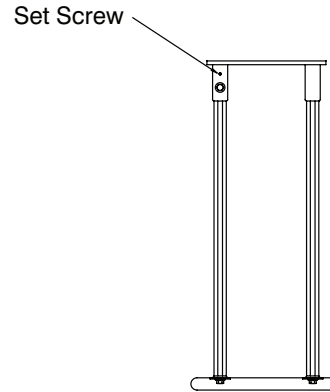
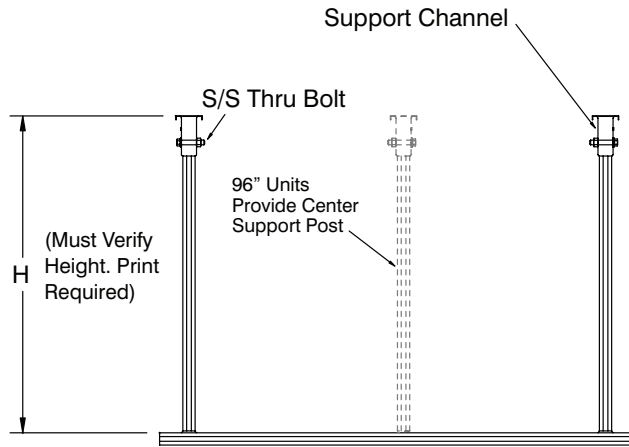

*96" Units Provided With 3 Support Posts

DOUBLE SHELVES

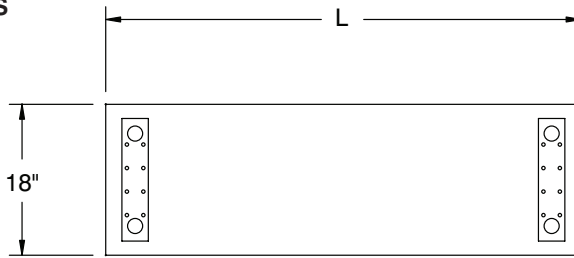

CUSTOMER MUST PROVIDE PRINT

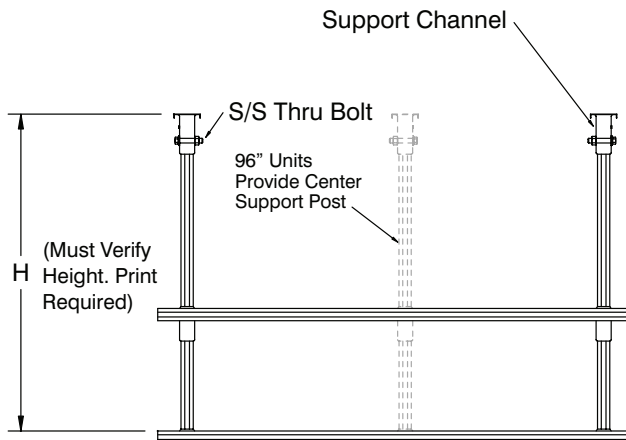

Adjustable Shelf

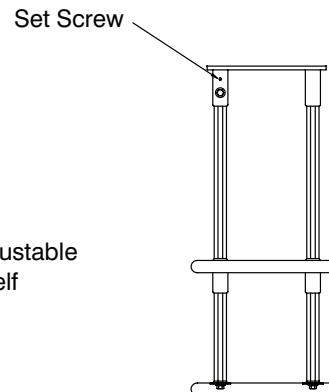

*96" Units Provided With 3 Support Posts

