

FlexiWell

Mobile hot and cold combination serving counters

FlexiWell

Models

- SFW-1-NU 1 Well hot and cold combo
- SFW-2-NU 2 Well hot and cold combo
- SFW-3-NU 3 Well hot and cold combo
- SFW-4-NU 4 Well hot and cold combo
- SFW-5-NU 5 Well hot and cold combo
- SFW-6-NU 6 Well hot and cold combo



SFW-4-NU

Standard Features

- NSF-4 and NSF7 certified for hot and or cold operation
- Wells operate independently for hot or cold operation and vice versa
- Stainless steel immersion heaters - one per well
- Control panel(s) with 3 way hot/cold/off switch and thermostat for hot operation
- Electronic temperature control
- Adjustable pan support for flush mounted hot operation or 2" recessed cold operation
- Stainless steel top and exterior body
- 14 gauge galvanized bottom
- Cord and plug supplied standard
- High density environmentally friendly, Kyoto Protocol compliant, Non ODP (Ozone Depletion Potential polyurethane foam throughout
- Environmentally friendly R290 GreenGenius refrigerant
- 2 year parts and labor warranty standard

Options & Accessories

- Counter heights available from 28" to 36"
- Tray slides and work shelves
- Food shields
- Stainless steel overshef
- Laminated exterior
- Décor packages

Specifications

Top: Exterior top is constructed of 14-gauge stainless steel, welded, ground and polished into one integral unit. Top is fabricated with square exterior corners.

Interior: Interior liner is constructed of stainless steel with a 1" (2.5cm) drain. Adjustable stainless steel pan rest for flush mount heating or 2" (5cm) recessed cooling to accommodate up to 6" (15cm) deep 12" x 20" plans, supplier by others. Stainless steel immersion heater(s) installed in bottom for wet only heating operation.

Exterior body: is constructed of 18-gauge stainless steel side panels and 14-gauge galvanized bottom. All exterior side panels are reinforced with overlapping corners and are welded in place. All body cutouts are reinforced with 14-gauge galvanized channel supports.

Castors: unit is mounted on 5" (13cm) diameter swivel casters with non-marking polyurethane casters and pate brakes. Overall height of caster assembly is 6" (15cm)



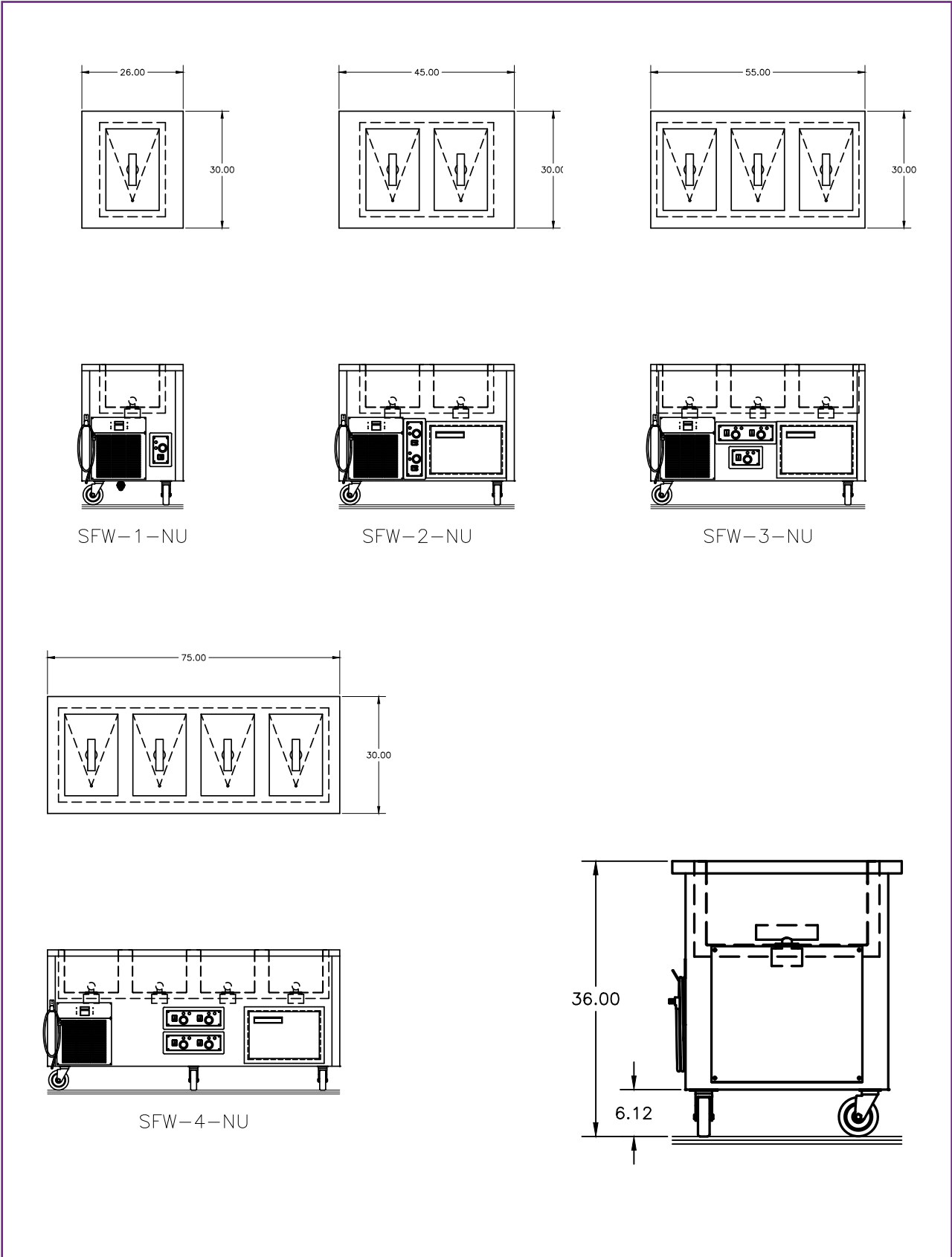

Welbilt reserves the right to make changes to the design or specifications without prior notice.

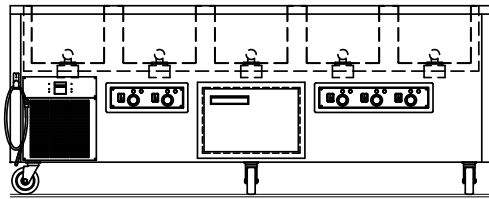
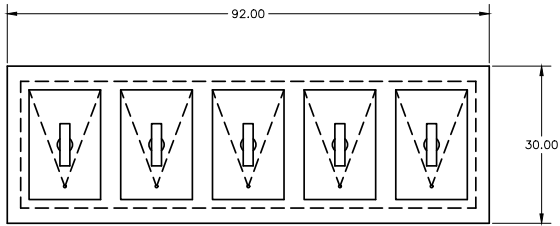

SFW-5-NU

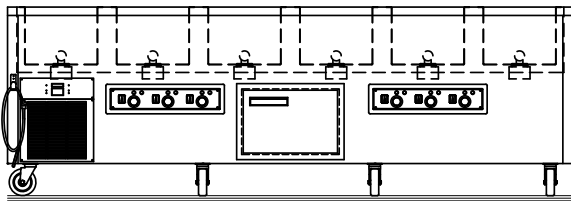
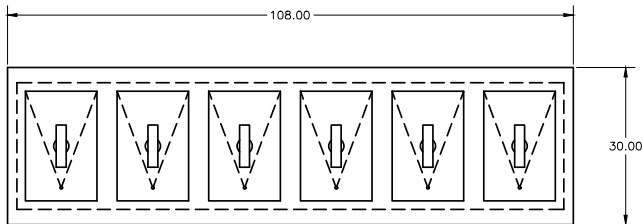

SFW-6-NU

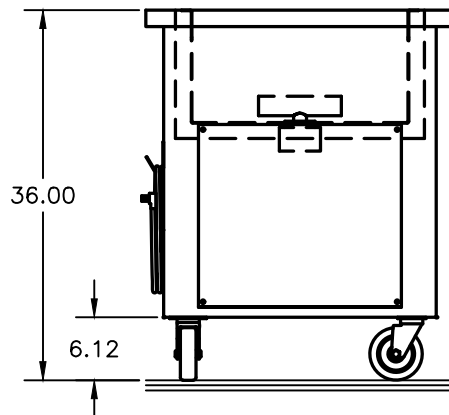

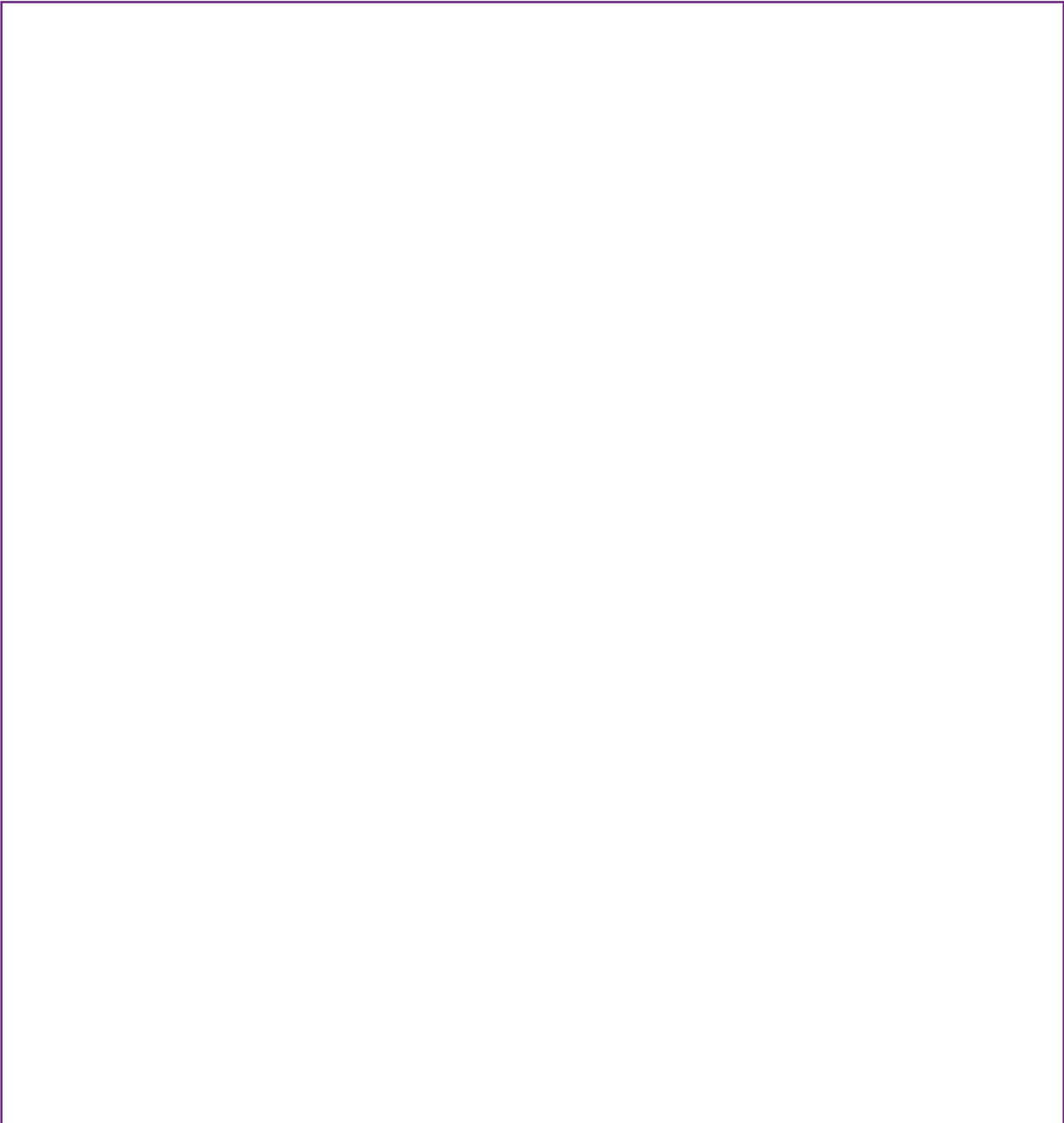

Specifications							
Model	12" x 20" Pan Capacity	Hot Electrical	Cold Electrical	Nema Plug	BTU Load	System Capacity	Ship Weight
SFW-1-NU	1	1500W - 208-240V-6.3A	120V - 2.9A - 1/5 H.P	14-20P	310	625	300
SFW-2-NU	2	(2) 1500W - 208-240V-12.5A	120V - 2.9A - 1/5 H.P	14-20P	620	906	380
SFW-3-NU	3	(3) 1500W - 208-240V-18.8A	120V - 2.9A - 1/5 H.P	14-30P	929	1066	460
SFW-4-NU	4	(4) 1500W - 208-240V-25A	120V - 5.7A - (2) 1/5HP	14-50P	1239	1812	550
SFW-5-NU	5	(5) 1500W - 208-240V-31.3A	120V - 5.7A - (2) 1/5HP	14-50P	1549	1972	660
SFW-6-NU	6	(6) 1500W - 208-240V-37.5A	120V - 5.7A - (2) 1/5HP	14-50P	1859	2132	720

Welbilt reserves the right to make changes to the design or specifications without prior notice.