

Series GC, GB & GBS Reach-Ins CoolScapes™

Original Instructions Installation, Operation and Maintenance Manual

This manual is updated as new information and models are released. Visit our website for the latest manual.



Safety Notices

⚠ Warning

Read this manual thoroughly before operating, installing or performing maintenance on the equipment. Failure to follow instructions in this manual can cause property damage, injury or death.

⚠ DANGER

Do not install or operate equipment that has been misused, abused, neglected, damaged, or altered/modified from that of original manufactured specifications.

⚠ DANGER

Keep power cord AWAY from HEATED surfaces. DO NOT immerse power cord or plug in water. DO NOT let power cord hang over edge of table or counter.

⚠ DANGER

All utility connections and fixtures must be maintained in accordance with Local and national codes.

⚠ Warning

Authorized Service Representatives are obligated to follow industry standard safety procedures, including, but not limited to, local/national regulations for disconnection / lock out / tag out procedures for all utilities including electric, gas, water and steam.

⚠ Warning

Do not store or use gasoline or other flammable vapors or liquids in the vicinity of this or any other appliance. Never use flammable oil soaked cloths or combustible cleaning solutions, for cleaning.

⚠ Warning

This product contains chemicals known to the State of California to cause cancer and/or birth defects or other reproductive harm. Operation, installation, and servicing of this product could expose you to airborne particles of glasswool or ceramic fibers, crystalline silica, and/or carbon monoxide. Inhalation of airborne particles of glasswool or ceramic fibers is known to the State of California to cause cancer. Inhalation of carbon monoxide is known to the State of California to cause birth defects or other reproductive harm.

⚠ Warning

Do not use electrical appliances or accessories other than those supplied by the manufacturer.

⚠ Warning

Use caution when handling metal surface edges of all equipment.

⚠ Warning

This appliance is not intended for use by persons (including children) with reduced physical, sensory or mental capabilities, or lack of experience and knowledge, unless they have been given supervision concerning use of the appliance by a person responsible for their safety. Do not allow children to play with this appliance.

⚠ Caution

Use caution handling, moving and use of the R290 refrigerators to avoid either damaging the refrigerant tubing or increasing the risk of a leak. Components shall be replaced with like components. Servicing shall be done by a factory authorized service personnel to minimize the risk of possible ignition due to incorrect parts or improper service.

Notice

Proper installation, care and maintenance are essential for maximum performance and trouble-free operation of your equipment. Visit our website www.mtwkitchencare.com for manual updates, translations, or contact information for service agents in your area.

Notice

This product utilizes Ecomate blowing agent methyl formate

Table of Contents

Section 1

General Information

Model Numbers	5
Serial Number Information	5
Warranty Information	5
Regulatory Certifications	5

Section 2

Installation

Location	7
Weight of Equipment	8
Clearance Requirements.....	8
Drain Connections.....	8
Dimensions	9
Electrical Service	10
Refrigeration	11
Leveling.....	12
Stabilizing.....	12
Leg & Caster Installation.....	12
Shelf Installation	13
Applicable to GC Models.....	13
Applicable to GB Models.....	13
Reversible Full Door Instructions.....	14
New top Hinge Supplied with GB Models.....	14
GC Alternate Hinge Must Be Purchased.....	14
Reversible Half Door Instructions.....	15
New Top and Center Hinges Must Be Purchased.....	15
Pilaster Clip Kit Installation Instructions.....	17
Applicable to GC Models.....	17
New Bottom Hinge Cartridge Installation.....	18
T-1 Tray Slide Installation	19
T-2 Tray Slide Installation	20
T-3 Tray Slide Installation	21
T-4 Rack Slide Installation	22

Section 3

Operation

R290 Controls/Programming/Settings.....	23
R290 Temperature Control & Display	24
R290 Evaporator Fan Operation.....	25
R290 Changing Display from Fahrenheit to Celsius on ERC112 Control.....	26

Section 4

Maintenance

Cleaning and Sanitizing Procedures.....	27
General.....	27
Interior Cleaning.....	28
Exterior Cleaning.....	28
Drain.....	29
Cleaning the Condenser Coil	29
Casters.....	29
Doors/Hinges.....	29
Preventing Blower Coil Corrosion	29

**Section 5
Troubleshooting**

Problem -> Cause -> Correction Chart.....31

Section 1

General Information

Model Numbers

This manual covers the following models:

1 Section Refrigerators	
Glass Doors	Solid Doors
GBR1P-G(H)	GBR1P-S(H)
GBSR1P-G(H)	GBSR1P-S(H)
GCR1P-G(H)	GCR1P-S(H)

2 Section Refrigerators	
Glass Doors	Solid Doors
GBR2P-G(H)	GBR2P-S(H)
GBSR2P-G(H)	GBSR2P-S(H)
GCR2P-G(H)	GCR2P-S(H)

3 Section Refrigerators	
Glass Doors	Solid Doors
GBR3P-G(H)	GBR3P-S(H)
GBSR3P-G(H)	GBSR3P-S(H)
GCR3P-G(H)	GCR3P-S(H)

Solid Doors Freezers		
1 Section	2 Section	3 Section
GBF1P-S(H)	GBF2P-S(H)	GBF3P-S(H)
GBSF1P-S(H)	GBSF2P-S(H)	GBSF3P-S(H)
GCF1P-S(H)	GCF2P-S(H)	GCF3P-S(H)

Serial Number Information

The serial number is on the identification plate that also includes the model number. The identification plate is located near the top front corner of the left interior wall.

Always have the serial number of your unit available when calling for parts or service.

Warranty Information



Visit

<http://www.delfield.com/warranty> to:

- Register your product for warranty.
- Verify warranty information.
- View and download a copy of your warranty.

Regulatory Certifications

Models are certified by:

-  National Sanitation Foundation (NSF)
-  Underwriters Laboratories (UL)
-  Underwriters Laboratories of Canada (cUL)

THIS PAGE INTENTIONALLY LEFT BLANK

Section 2 Installation

DANGER

Installation must comply with all applicable fire and health codes in your jurisdiction.

DANGER

Use appropriate safety equipment during installation and servicing.

Warning

Do not damage the refrigeration circuit when installing, maintaining or servicing the unit.

Location

Warning

This equipment must be positioned so that the plug is accessible unless other means for disconnection from the power supply (e.g., circuit breaker or disconnect switch) is provided.

Warning

Adequate means must be provided to limit the movement of this appliance without depending on or transmitting stress to the electrical conduit or gas lines.

Warning

To avoid instability the installation area must be capable of supporting the combined weight of the equipment and product. Additionally the equipment must be level side to side and front to back.

Warning

This equipment is intended for indoor use only. Do not install or operate this equipment in outdoor areas.

The location selected for the equipment must meet the following criteria. If any of these criteria are not met, select another location.

- The location **MUST** be level, stable and capable of supporting the weight of the equipment.
- The location **MUST** be free from and clear of combustible materials.
- Equipment **MUST** be level both front to back and side to side.
- Position the equipment so it will not tip or slide.
- Front casters **MUST** be locked once positioned.
- Recommended air temperature is 60° - 100°F (16° - 38°C).
- Proper air supply for ventilation is **REQUIRED AND CRITICAL** for safe and efficient operation. Refer to Clearance Requirements chart on page 8.
- Do not obstruct the flow of ventilation air. Make sure the air vents of the equipment are not blocked.
- Do not install the equipment directly over a drain. Steam rising up out of the drain will adversely affect operation, air circulation, and damage electrical / electronic components.

Weight of Equipment

Description	Models	Weight
1 Section Refrigerators		
Glass Doors	GBR1P-G(H), GBSR1P-G(H), GCR1P-G(H)	236 lbs (107 kg)
Solid Doors	GBR1P-S(H)	312 lbs (142 kg)
	GBSR1P-S(H)	351 lbs (159 kg)
	GCR1P-S(H)	282 lbs (128 kg)
2 Section Refrigerators		
Glass Doors	GBR2P-G(H), GBSR2P-G(H), GCR2P-G(H)	322 lbs (146 kg)
Solid Doors	GBR2P-S(H), GBSR2P-S(H)	495 lbs (225 kg)
	GCR2P-S(H)	430 lbs (195 kg)
3 Section Refrigerators		
Glass Doors	GBR3P-G, GBSR3P-G, GCR3P-G	485 lbs (220 kg)
Solid Doors	GBR3P-S(H)	727 lbs (330 kg)
	GBSR3P-S(H)	767 lbs (348 kg)
	GCR3P-S(H)	668 lbs (303 kg)
1 Section Freezers		
Solid Doors	GBF1P-S(H)	336 lbs (152 kg)
	GBSF1P-S(H)	354 lbs (161 kg)
	GCF1P-S(H)	299 lbs (136 kg)
2 Section Freezers		
Solid Doors	GBF2P-S(H)	532 lbs (241 kg)
	GBSF2P-S(H)	495 lbs (225 kg)
	GCF2P-S(H)	445 lbs (202 kg)
3 Section Freezers		
Solid Doors	GBF3P-S(H), GBSF3P-S(H)	772 lbs (350 kg)
	GCF3P-S(H)	707 lbs (321 kg)

Clearance Requirements

DANGER

Minimum clearance requirements are the same for noncombustible locations as for combustible locations. The flooring under the appliance must be made of a noncombustible material.

DANGER

Risk of fire/shock. All minimum clearances must be maintained. Do not obstruct vents or openings.

Top

12.00" (305mm)

- Keep the vents clean and free of obstruction.
- Casters or optional legs must be used and not removed.

Drain Connections

Warning

Moisture collecting from improper drainage can create a slippery surface on the floor and a hazard to employees. It is the owner's responsibility to provide a container or outlet for drainage.

Dimensions

Model	Length	Depth	Height
1 Section Refrigerators			
GBR1P-G(H), GBR1P-S(H), GBSR1P-G(H), GBSR1P-S(H), GCR1P-G(H), GCR1P-S(H)	27.34" (70cm)	32.44" (82cm)	79.50" (202cm)
2 Section Refrigerators			
GBR2P-G(H), GBR2P-S(H), GBSR2P-G(H), GBSR2P-S(H), GCR2P-G(H), GCR2P-S(H)	55.16" (140cm)	32.44" (82cm)	79.50" (202cm)
3 Section Refrigerators			
GBR3P-G, GBR3P-S(H), GBSR3P-G, GBSR3P-S(H), GCR3P-G, GCR3P-S(H),	82.97" (211cm)	32.44" (82cm)	79.50" (202cm)
1 Section Freezers			
GBF1P-S(H), GBSF1P-S(H), GCF1P-S(H)	27.34" (70cm)	32.44" (82cm)	79.50" (202cm)
2 Section Freezers			
GBF2P-S(H), GBSF2P-S(H), GCF2P-S(H)	55.16" (140cm)	32.44" (82cm)	79.50" (202cm)
3 Section Freezers			
GBF3P-S(H), GBSF3P-S(H), GCF3P-S(H)	82.97" (211cm)	32.44" (82cm)	79.50" (202cm)

Model	Volume
1 Section Refrigerators	
GBR1P-G(H), GBR1P-S(H), GBSR1P-G(H), GBSR1P-S(H), GCR1P-G(H), GCR1P-S(H)	21ft ³ (595L)
2 Section Refrigerators	
GBR2P-G(H), GBR2P-S(H), GBSR2P-G(H), GBSR2P-S(H), GCR2P-G(H), GCR2P-S(H)	46ft ³ (1303L)
3 Section Refrigerators	
GBR3P-G, GBR3P-S(H), GBSR3P-G, GBSR3P-S(H), GCR3P-G, GCR3P-S(H),	71ft ³ (2010L)
1 Section Freezers	
GBF1P-S(H), GBSF1P-S(H), GCF1P-S(H)	21ft ³ (595L)
2 Section Freezers	
GBF2P-S(H), GBSF2P-S(H), GCF2P-S(H)	46ft ³ (1303L)
3 Section Freezers	
GBF3P-S(H), GBSF3P-S(H), GCF3P-S(H)	71ft ³ (2010L)

Electrical Service

DANGER

Check all wiring connections, including factory terminals, before operation. Connections can become loose during shipment and installation.

Warning

This appliance must be grounded and all field wiring must conform to all applicable local and national codes. Refer to rating plate for proper voltage. It is the responsibility of the end user to provide the disconnect means to satisfy the authority having jurisdiction.

- Plug units with R290 refrigerant into a receptacle that is a minimum of 14" (36cm) above the floor.
- All electrical work, including wire routing and grounding, must conform to local, state and national electrical codes.
- The equipment must be grounded.
- A separate fuse/circuit breaker must be provided for each unit.
- Check all green ground screws, cables and wire connections to verify they are tight before start-up.
- The maximum allowable voltage variation is ±10% of the rated voltage at equipment start-up (when the electrical load is highest).

Ground Fault Circuit Interrupter

Ground Fault Circuit Interrupter (GFCI/GFI) protection is a system that shuts down the electric circuit (opens it) when it senses an unexpected loss of power, presumably to ground. Manitowoc does not recommend the use of GFCI/GFI circuit protection to energize our equipment. If code requires the use of a GFCI/GFI then you must follow the local code. The circuit must be dedicated, sized properly and there must be a panel GFCI/GFI breaker. We do not recommend the use of GFCI/GFI outlets to energize our equipment as they are known for more intermittent nuisance trips than panel breakers.

Rated Amperages, Horsepower, Voltage & Power Cord Chart

Maximum 10ft (3m) cord with plug.

		Models	Amps	HP	V, Hz, Ph	NEMA Plug
Refrigerators	1 Section	GBR1P-G(H), GBR1P-S(H), GBSR1P-G(H), GBSR1P-S(H), GCR1P-G(H) GCR1P-S(H)	4.2	0.22	115, 60, 1	5-15p
	2 Section	GBR2P-G(H), GBR2P-S(H), GBSR2P-G(H), GBSR2P-S(H), GCR2P-G(H) GCR2P-S(H)	6.0	0.35	115, 60, 1	5-15p
	3 Section	GBR3P-G, GBR3P-S(H), GBSR3P-G, GBSR3P-S(H), GCR3P-G GCR3P-S(H)	6.5	0.38	115, 60, 1	5-15p
Freezers	1 Section	GBF1P-S(H), GBSF1P-S(H), GCF1P-S(H)	7.2	0.55	115, 60, 1	5-15p
	2 Section	GBF2P-S(H), GBSF2P-S(H), GCF2P-S(H)	10.0	0.68	115, 60, 1	5-15p
	3 Section	GBF3P-S(H), GBSF3P-S(H), GCF3P-S(H)	14.7	0.55 (x2)	115, 60, 1	5-20P

Energy Use For Energy Star® Certified Units

		Models	Energy Use in kWh
Refrigerators	1 Section	GBR1P-G, GBSR1P-G, GCR1P-G	2.08
		GBR1P-GH, GBSR1P-GH, GCR1P-GH	1.66
		GBR1P-S, GBSR1P-S, GCR1P-S	1.85
	2 Section	GBR1P-SH, GBSR1P-SH, GCR1P-SH	1.70
		GBR2P-G, GBSR2P-G, GCR2P-G	3.18
		GBR2P-GH, GBSR2P-GH, GCR2P-GH	2.91
		GBR2P-S, GBSR2P-S, GCR2P-S	2.71
	3 Section	GBR2P-SH, GBSR2P-SH, GCR2P-SH	2.49
		GBR3P-G, GBSR3P-G, GCR3P-G	4.92
GBR3P-S, GBSR3P-S, GCR3P-S		3.59	
	GBR3P-SH, GBSR3P-SH, GCR3P-SH	3.54	

Models			Energy Use in kWh
Freezers	1 Section	GBF1P-S, GBSF1P-S, GCF1P-S	5.78
		GBF1P-SH, GBSF1P-SH, GCF1P-SH	5.59
	2 Section	GBF2P-S, GBSF2P-S, GCF2P-S	10.65
		GBF2P-SH, GBSF2P-SH, GCF2P-SH	9.69
	3 Section	GBF3P-S, GBSF3P-S, GCF3P-S	10.50
		GBF3P-SH, GBSF3P-SH, GCF3P-SH	12.20

Refrigeration

Model	BTU/Hour Capacity	Heat of Rejection (BTU)	Charge	
1 Section Refrigerators				
Glass	Full Height Doors GBR1P-G, GBSR1P-G, GCR1P-G	1920	490	113g
	Half Height Doors GBR1P-GH, GBSR1P-GH, GCR1P-GH	1920	540	113g
Solid	Full Height Doors GBR1P-S, GBSR1P-S, GCR1P-S	1920	385	113g
	Half Height Doors GBR1P-SH, GBSR1P-SH, GCR1P-SH	1920	400	113g
2 Section Refrigerators				
Glass	Full Height Doors GBR2P-G, GBSR2P-G, GCR2P-G	2540	780	113g
	Half Height Doors GBR2P-GH, GBSR2P-GH, GCR2P-GH	2540	880	113g

Model	BTU/Hour Capacity	Heat of Rejection (BTU)	Charge	
Solid	Full Height Doors GBR2P-S, GBSR2P-S, GCR2P-S	2540	565	113g
	Half Height Doors GBR2P-SH, GBSR2P-SH, GCR2P-SH	2540	590	113g
3 Section Refrigerators				
Glass	Full Height Doors GBR3P-G, GBSR3P-G, GCR3P-G	3865	1175	118g
Solid	Full Height Doors GBR3P-S, GBSR3P-S, GCR3P-S	3865	850	118g
	Half Height Doors GBR3P-SH, GBSR3P-SH, GCR3P-SH	3865	895	118g
1 Section Freezers				
Solid	Full Height Doors GBF1P-S, GBSF1P-S, GCF1P-S	2035	760	93g
	Half Height Doors GBF1P-SH, GBSF1P-SH, GCF1P-SH	2035	790	93g
2 Section Freezers				
Solid	Full Height Doors GBF2P-S, GBSF2P-S, GCF2P-S	2485	1275	109g
	Half Height Doors GBF2P-SH, GBSF2P-SH, GCF2P-SH	2485	1340	109g
3 Section Freezers				
Solid	Full Height Doors GBF3P-S, GBSF3P-S, GCF3P-S	4065	1700	109g/system
	Half Height Doors GBF3P-SH, GBSF3P-SH, GCF3P-SH	4065	1795	109g/system

Leveling

After the cabinet has been placed in the desired location, cabinets with legs must be leveled. Level units from front to back and from side to side. Leveling will insure proper door operation and removal of condensate. Cabinets with casters must have the caster brake set so the cabinet cannot move.

Stabilizing

It is very important that all legs are properly adjusted to keep the cabinet level, evenly distribute the weight and to make sure the unit will not rock, lean or be unstable.

Leg & Caster Installation

! DANGER

Legs or casters must be installed and the legs or casters must be screwed in completely to prevent bending. When casters are installed the mass of this unit will allow it to move uncontrolled on an inclined surface. These units must be tethered/secured to comply with all applicable codes.

⚠ Warning

The unit must be installed in a stable condition with the front wheels locked. Locking the front casters after installation is the owner's and operator's responsibility.

⚠ Warning

Use a jack to lift the refrigeration unit off the ground just far enough to remove the leg/caster. Place blocking underneath the unit. Do not work underneath a raised unit without proper blocking. Do not lift the unit more than necessary to remove the leg/caster. Lifting the unit too far can make the unit unstable.

⚠ Caution

All single-section units require that the swivel casters be mounted on the front and rigid casters be mounted on the rear.

To install the legs or casters:

1. Remove unit from skid.

NOTE: The bolts used to hold the unit to the skid should be re-used as the fourth hex head bolt for each caster or leg plate installation. The bolt should not measure over 2" (5cm) in length.

2. Raise unit to access leg/caster mounting holes on bottom of unit.
3. Attach the legs or casters to bottom of cabinet using hex head bolts.

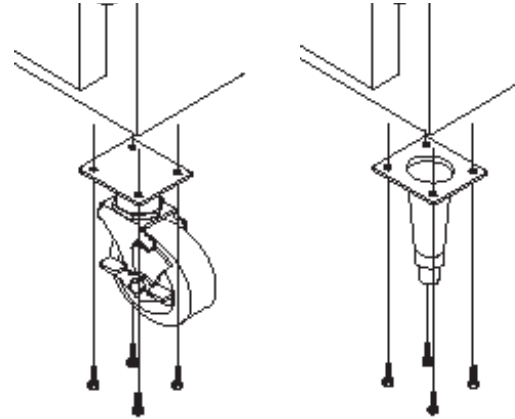

Shelf Installation

APPLICABLE TO GC MODELS

1. If the shelves are attached to the shelf pins, detach the shelves and set them aside. Cut zip ties if necessary.
2. Tighten the shelf pins to the refrigerator side walls and mullions.

⚠ Caution

Shelf pins can become damaged and unusable if shelves are loaded while the pins are loose.

3. Place the shelves back on the pins.

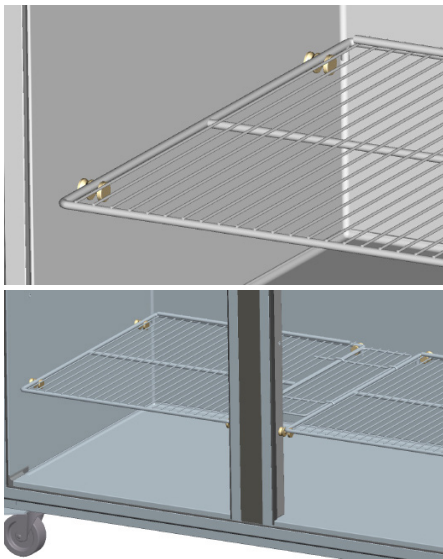

APPLICABLE TO GB MODELS

1. Insert the clips into the pilaster holes at the desired shelf heights.

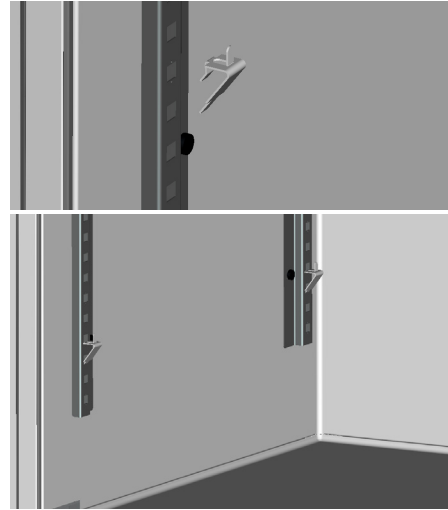

2. Set the shelves on the clips.

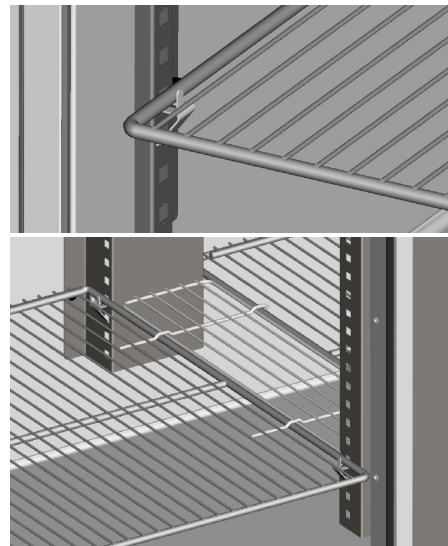

Reversible Full Door Instructions

NEW TOP HINGE SUPPLIED WITH GB MODELS

GC ALTERNATE HINGE MUST BE PURCHASED

1. Open the door.
2. Remove two bolts securing the hinge bracket above the door.

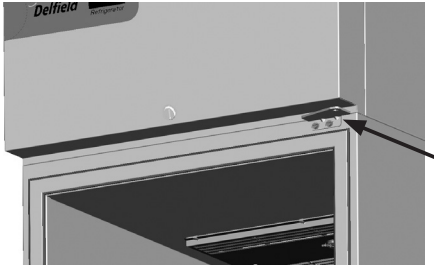

3. Lift the door up and out.
4. Save the hinge bracket.
5. Remove three bolts securing the hinge bracket to the bottom of the unit.

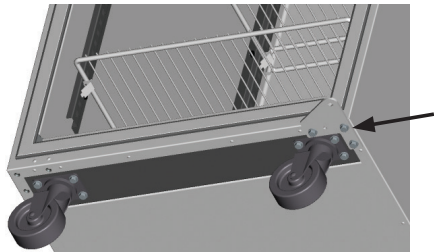

6. Flip it over and install it on the opposite side.

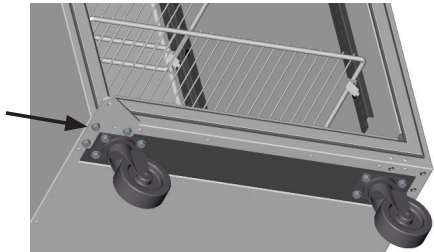

7. Rotate the door 180°.
8. Move the white nylon washer from the top hinge pin to the bottom hinge pin.

9. Insert the bottom hinge pin into the hinge bracket.

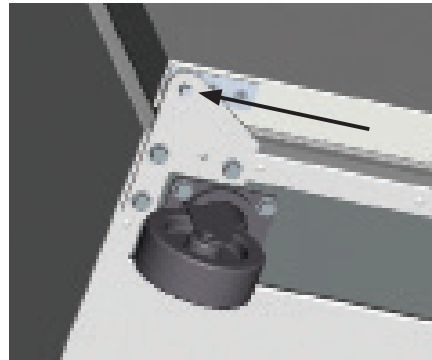

10. Locate the provided alternate top hinge bracket.

11. Place the hinge bracket over the top hinge pin.

12. Open the door.

13. Using the original screws install the hinge bracket on the new side in the vacant lock holes.

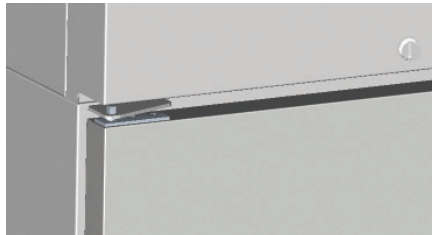
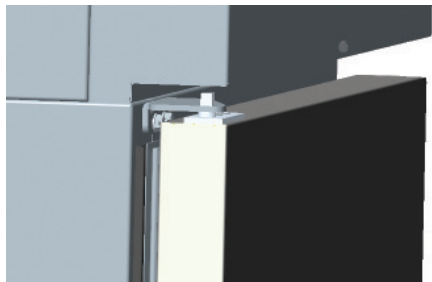

14. Check for proper closure and gasket seal.

15. Adjust hinges as needed.

Reversible Half Door Instructions

NEW TOP AND CENTER HINGES MUST BE PURCHASED

Remove Lock Box

1. Open both doors.
2. Drill out the pop rivets that secure the lock box to the bottom of the top door. Set the lock box aside.

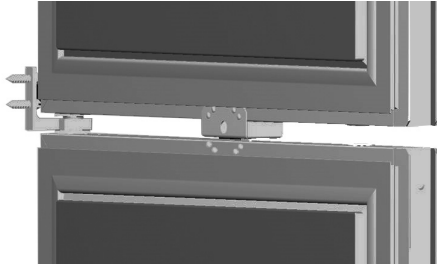

3. Remove the white plugs from the top of the bottom door and insert them into the new holes just drilled in the bottom of the top door.

Remove Both Doors

4. Open the top door.
5. Remove two bolts securing the hinge bracket above the door.

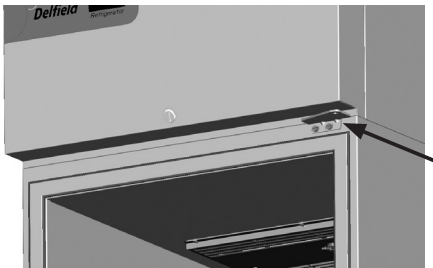

6. Lift the top door up and out.
7. Set the screws aside to be reused.
8. Have someone hold the bottom door. Remove the hex head screws holding the center hinge bracket. Save the white nylon washer.

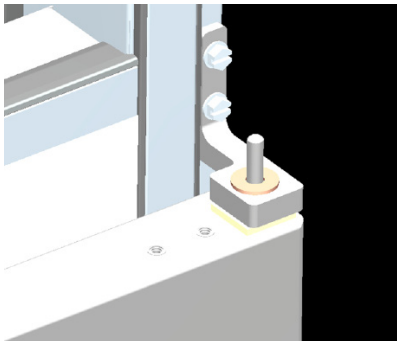

9. Remove the bottom door off the bottom hinge bracket.

10. Remove three bolts securing the hinge bracket to the bottom of the unit.

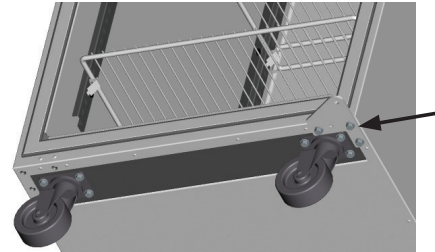

11. Flip the hinge bracket over and install it on the opposite side. Put the white nylon washer on the bottom bracket centered over the square hole.

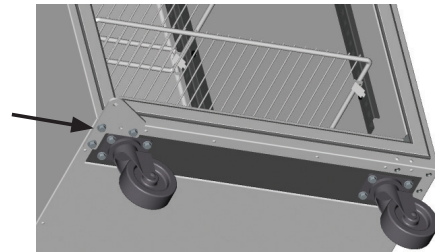

Install Bottom Door

12. Rotate the top door 180° for use as the bottom door.
13. Slide the old top hinge bracket over bottom hinge pin.

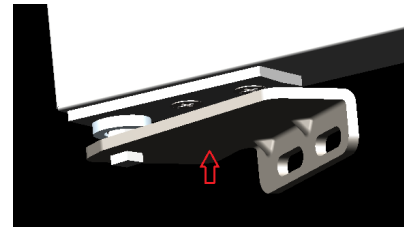

14. Using the top hinge bracket rotate the pin 90 degrees inward. This loads the tension on the door hinge cartridge.

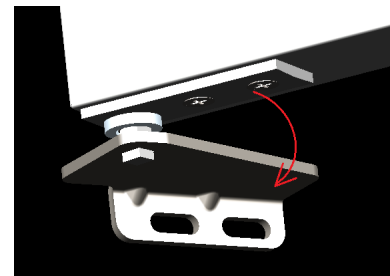

15. Remove the top hinge bracket.

16. With the aid of a second person, hold the door at 90 degrees to the front of the cabinet and slide the bottom hinge pin into bottom hinge bracket hole.

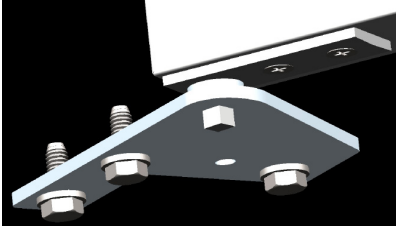

17. Holding onto bottom door, close door until tight to front of cabinet.
18. Slide new provided center hinge bracket pin down into white bushing in the top of the bottom door. Mount center hinge bracket with (2) hex head screws.
19. Place the saved white nylon bushing on the hinge pin.

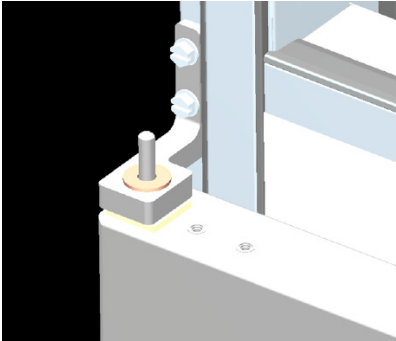

Install Top Door

20. Rotate bottom door 180° for use as the top door.
21. Slide the old top hinge bracket over top hinge pin. Then rotate the pin 90 degrees inward. This loads the tension on the door hinge cartridge.

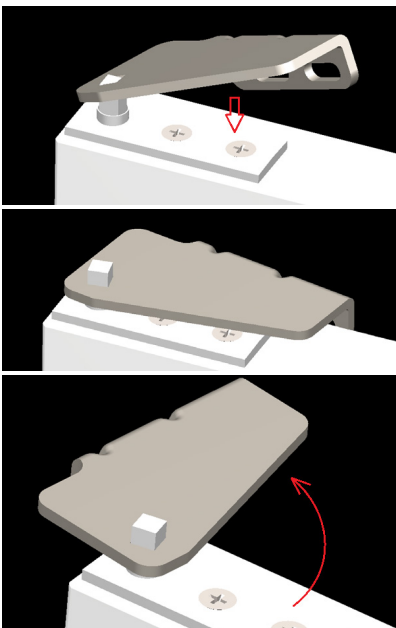

22. Holding the top door at 90 degrees to the cabinet, set the bushing on the center hinge pin.
23. Locate the provided alternate top hinge bracket.
24. Place the hinge bracket over the top hinge pin.
25. While someone holds the top door at 90 degrees to the cabinet, move the door toward the cabinet until the top hinge bracket is tight to the cabinet front.
26. Using the original screws install the hinge bracket on the new side in the vacant holes.

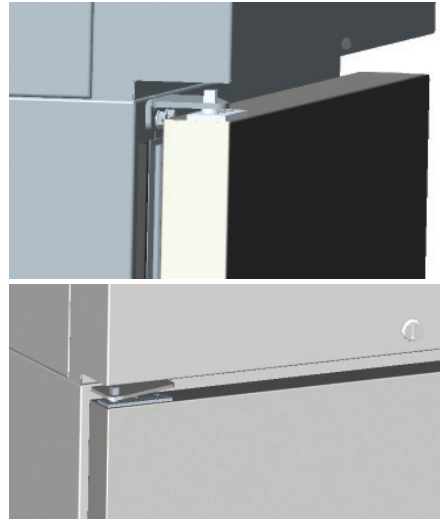

Reinstall Lock Box

27. Open the top door.
28. Install the lock box at the inside bottom of the top door.

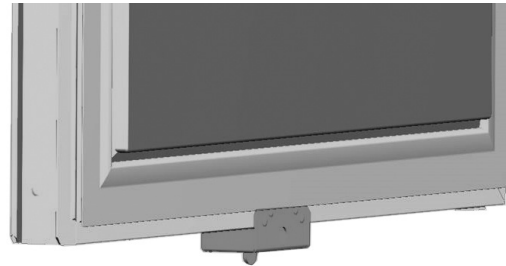

Quality Check

29. Doors should self-close once they are closed to less than 45 degrees. Adjust doors as needed to be square with the cabinet.
30. Check that the gaskets seal properly.
31. Adjust hinges as needed.

Pilaster Clip Kit Installation Instructions

APPLICABLE TO GC MODELS

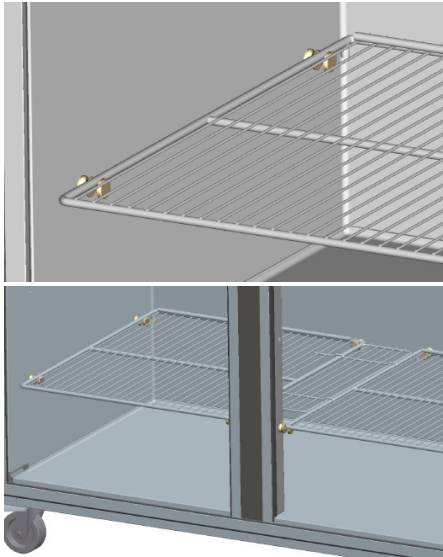

1. If the shelves are attached to the shelf pins, detach and set them aside. Cut zip ties if necessary.
2. Remove the shelf pins from refrigerator side walls and mullions. These holes will be used to mount the pilasters.

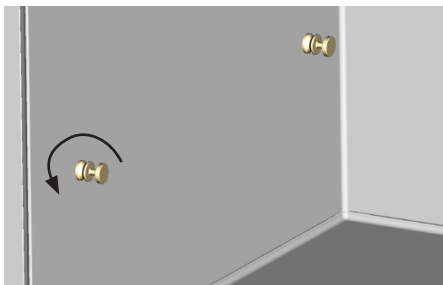

3. Match up the pilaster mounting holes with the refrigerator and mullion holes. Secure with provided screws.

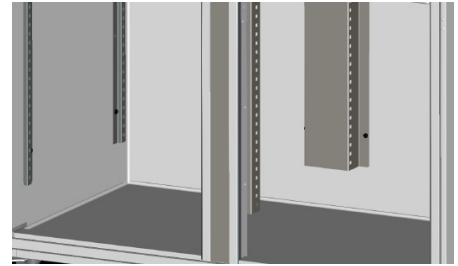
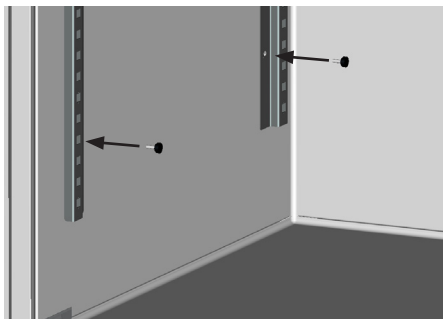

4. Insert the clips into the pilaster holes at the desired shelf heights.

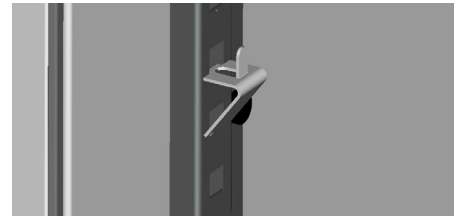
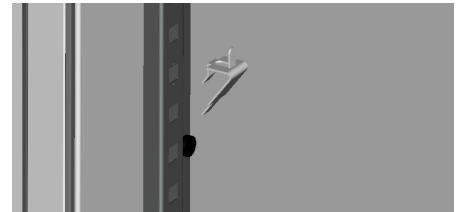

5. Set the shelves on the clips.

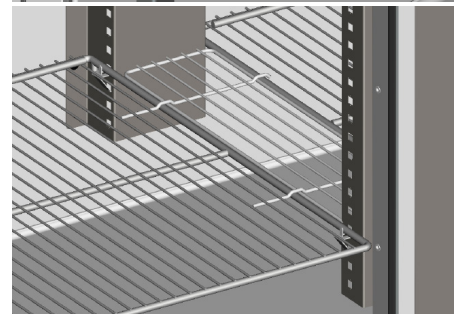
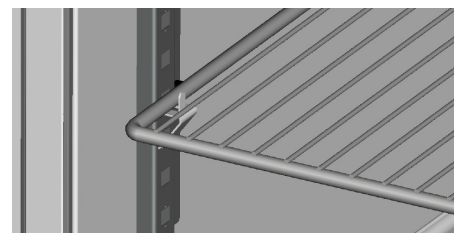

New Bottom Hinge Cartridge Installation

1. Install the new cartridge into the door as received. The new cartridge will be in the CLOSED position.



2. **As you unload the hinge tension be careful to hold on tight because you should feel the strong spring tension as you rotate the hinge.** Place the hinge bracket on the square hinge pin and rotate it ½ turn to the outside of the door.



3. After the hinge has been rotated, it will now be in the OPEN position and NOT under spring tension.



4. Mount the door back onto the cabinet with the door OPEN. The door should now close properly.
5. Begin closing the door, the door should finish closing on it's own. If the door stays open remove the door and hinge bracket.
6. Using the hinge bracket rotate the square peg on the cartridge until you feel tension and resistance if you move the hinge in either direction. The hinge is now in the CLOSED position. Repeat instructions starting with step 2.

T-1 Tray Slide Installation

Edge Support for 18" x 26" pans

APPLICABLE TO GB & GBS MODELS

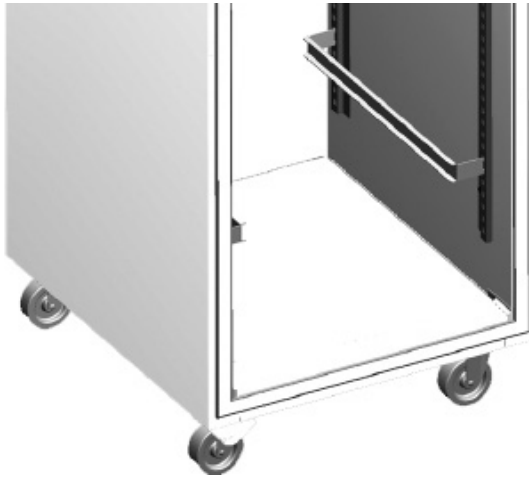

Installed T-1 Tray Slide for 18" x 26" Pans

System Name	T-1
Slide Style	Tray
Support Style	Edge
Compatible with 12" x 20" Pans	No
Compatible with 18" x 26" Pans	Yes

- The T-1 tray slide system is designed to support 18" x 26" pans by the edge of the pan.
- The slides are shaped as a C channel.
- Each set of tray slides is mounted at the same height across a door section.
- For each pan, one set of two (2) tray slides is used. The exception is 1.5" spacing.
- For 1.5" spacing, the tray slides are mounted every 3" and the top and bottom of each tray slide is used to hold a pan.

Centerline Spacing					
1.5"	2.0"	3.0"	4.0"	5.0"	6.0"
Maximum Tray Slides for a Full Section					
15	23	15	12	9	8
Maximum Tray Slides for a Half Section (Top or Bottom)					
7	10	7	5	4	4

T-1 Installation Instructions

1. For each pan, mount a pair of tray slides; one on each side of the door section at the same height. Mount the tray slides onto the pilasters by sliding the tray slide tabs down into the cutouts. Make sure that all tabs are engaged securely to each pilaster.

NOTE: A dead-blow hammer is recommended to seat the tab into the cutouts.

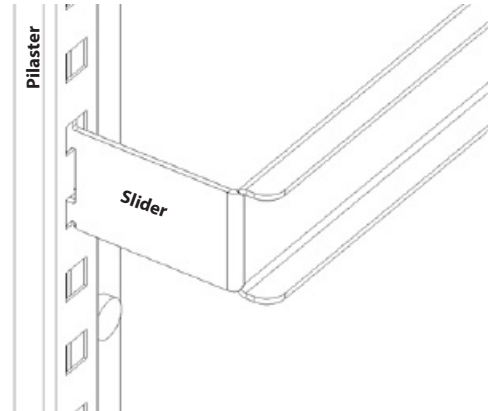

2. Verify that all tray slides are lined up evenly.

NOTE: An easy check to verify correct installation is to slide an 18" x 26" pan onto each slide. If the pan is held securely, and is level inside the door section, the installation has been successful.

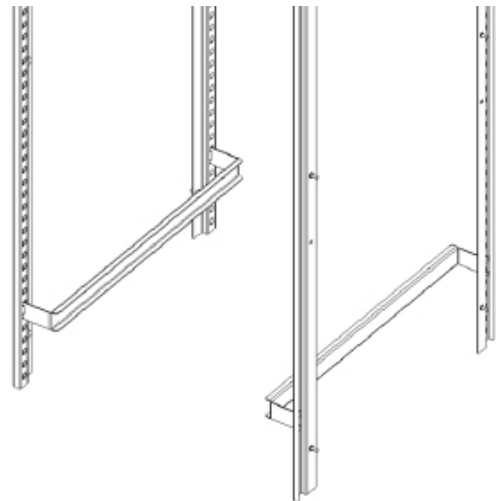

T-2 Tray Slide Installation

Universal Bottom Support for 12" x 20" and 18" x 26" pans

APPLICABLE TO GB & GBS MODELS



Installed T-2 tray slide with both size pans

System Name	T-2
Slide Style	Tray
Support Style	Bottom
Compatible with 12" x 20" Pans	Yes
Compatible with 18" x 26" Pans	Yes

- The T-2 (Universal) tray slide system is designed to support both 12" x 20" and 18" x 26" pans by the bottom.
- The tray slide is an L shaped piece of formed stainless steel.
- Each set of tray slides is mounted at the same height across a door section.
- For each pan, one set of two (2) tray slides is used.

Centerline Spacing				
2.0"	3.0"	4.0"	5.0"	6.0"
Maximum Tray Slides for a Full Section				
23	15	12	9	8
Maximum Tray Slides for a Half Section (Top or Bottom)				
10	7	5	4	4

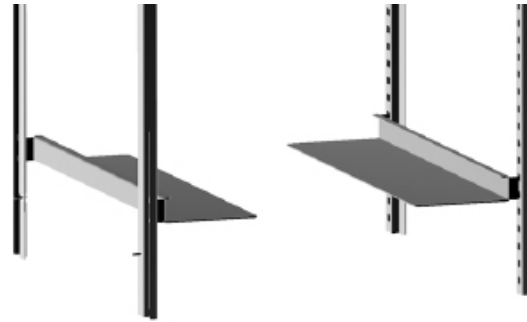

T-2 Tray Slide System

T-2 Installation Instructions

1. For each pan, two (2) tray slides will be used. Each tray slide must have another tray slide at the same height, on the opposite side of the door section. Mount the tray slides onto the pilasters by sliding the tabs down into the pilaster cutouts. Make sure that all tabs are engaged securely to each pilaster.

NOTE: A dead-blow hammer is recommended to seat the tab into the cutouts.

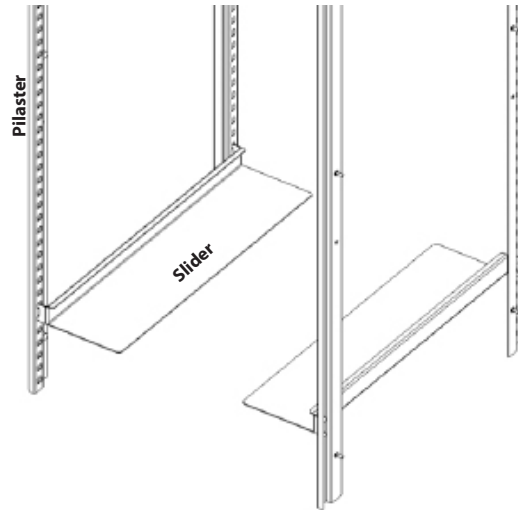

2. Verify that all tray slides are lined up evenly.

NOTE: An easy check to verify correct installation is to slide a pan onto each slide. If the pan is held securely, and is level inside the door section, the installation has been successful.

T-3 Tray Slide Installation

Edge Support for 12" x 20" pans

APPLICABLE TO GB & GBS MODELS



T-3 Tray Slide for 12" x 20" pans

System Name	T-3
Slide Style	Tray
Support Style	Edge
Compatible with 12" x 20" Pans	Yes
Compatible with 18" x 26" Pans	No

- The T-3 tray slide system is designed to support 12" x 20" pans by the edge of the pan.
- The slides are shaped as a C channel.
- Each set of tray slides is mounted at the same height across a door section.
- For each pan, one set of two (2) tray slides is used.

Centerline Spacing			
3.0"	4.0"	5.0"	6.0"
Maximum Tray Slides for a Full Section			
17	12	9	7
Maximum Tray Slides for a Half Section (Top)			
6	5	4	3
Maximum Tray Slides for a Half Section (Bottom)			
8	6	5	4

T-3 Installation Instructions

1. For each pan, two (2) tray slides will be used. Each tray slide must have another tray slide at the same height, on the opposite side of the door section. Mount the tray slides onto the pilasters by sliding the tabs down into the pilaster cutouts. Make sure that all tabs are engaged securely to each pilaster.

NOTE: A dead-blow hammer is recommended to seat the tab into the cutouts.

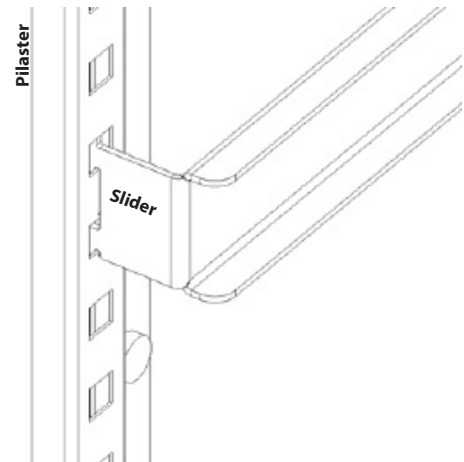

2. Verify that all tray slides are lined up evenly.

NOTE: An easy check to verify correct installation is to slide a pan of the appropriate size into each slide. If the pan is held securely, and is level inside the door section, the installation has been successful.

T-4 Rack Slide Installation

Edge Support for 18" x 26" pans

APPLICABLE TO GB & GBS MODELS

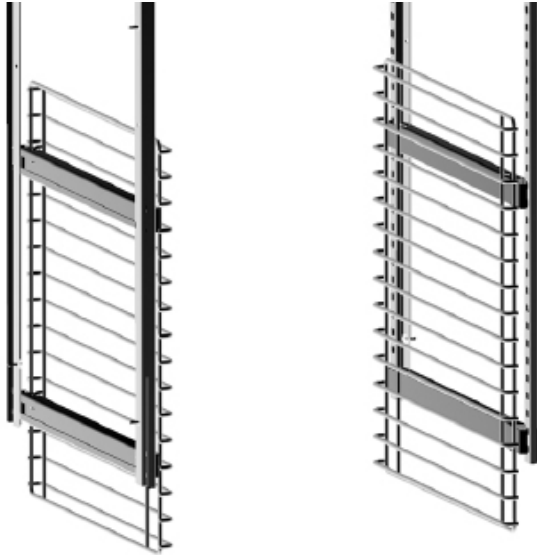

Installed T-4 Tray Slide for 18" x 26" pan

System Name	T-4
Slide Style	Rack
Support Style	Edge
Compatible with 12" x 20" Pans	No
Compatible with 18" x 26" Pans	Yes

- The T-4 rack slide system is designed to support 18" x 26" pans by the edge of the pan.
- The T-4 rack slide system consists mounting plates for each side, and a set of racks.
- The racks are formed of heavy gauge metal wire.
- Each set of rack slides is mounted at the same height across a door section.
- Each rack uses two (2) mounting plates.

T-4 Installation Instructions

1. Start assembling the mounting plates at the bottom of the door section. Place a bottom mounting plate so that each set of tabs engages a cutout on the pilaster. Push the mounting plate down to secure the plate to the cutouts.

NOTE: A dead-blow hammer is recommended to seat the tab into the cutouts.

2. On the same side place a top mounting plate with the bottom edge 20" (51cm) above the top of the lower mounting plate.

3. Repeat steps 1-2 on the opposite side. Verify that all mounting plates are lined up across the door section.
4. For a full section installation, repeat steps 1-3 for the upper half.
5. Place each rack on two (2) mounting plates.

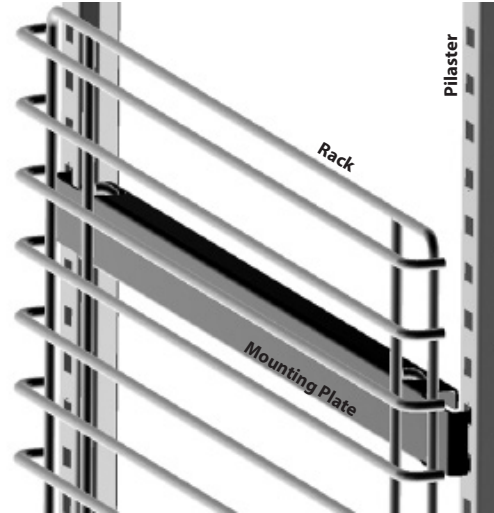

6. Verify that all tray slides are lined up evenly.

NOTE: An easy check to verify correct installation is to slide a pan of the appropriate size into each slide. If the pan is held securely, and is level inside the door section, the installation has been successful.

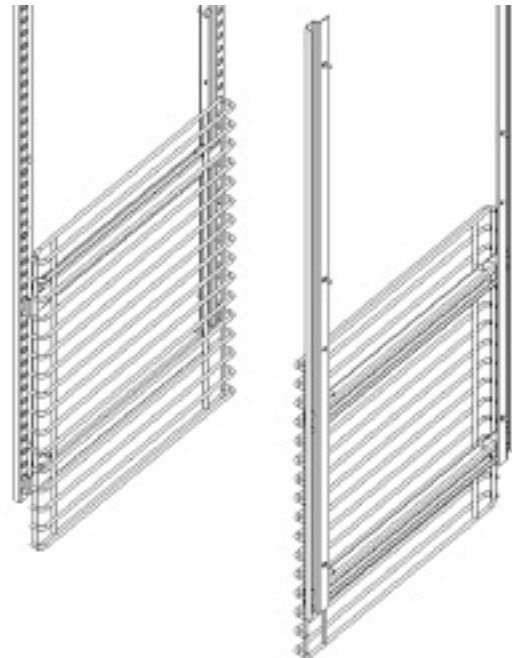

Section 3 Operation

DANGER

Do not operate any appliance with a damaged cord or plug. All repairs must be performed by a qualified service company.

DANGER

Never stand on the unit! They are not designed to hold the weight of an adult, and may collapse or tip if misused in this manner.

Warning

Do not contact moving parts.

Warning

All covers and access panels must be in place and properly secured, before operating this equipment.

Warning

Do not use electrical appliances inside the food storage compartment of this appliance.

Warning

The operator of this equipment is solely responsible for ensuring safe holding temperature levels for all food items. Failure to do so could result in unsafe food products for customers.

Warning

Overloading shelves can damage equipment or cause bodily injury.

Warning

Damp or wet hands may stick to cold surfaces.

Warning

Do not block the supply and return air grills or the air space around the air grills. Keep plastic wrappings, paper, labels, etc. from being airborne and lodging in the grills. Failure to keep the air grills clear will result in unsatisfactory operation of the system.

Caution

Do not throw items into the storage area. Failure to heed this recommendation could result in damage to the interior of the cabinet or to the blower coil.

R290 Controls/Programming/Settings

R290 Refrigerator

Refrigerators are factory set at mid-range to maintain about 38°F (3°C) box temperature.

1. At initial start-up or anytime power is disconnected, then reconnected to the unit, the control will go into defrost mode.
2. The control will enter a DEFROST mode and the display will read dEF. The compressor and condenser fan as well as the evaporator fan will remain off until this initial defrost is complete. This initial defrost cycle may take up to 35 minutes to complete.
3. The display will continue to read dEF for an additional 30 minutes while the cooling cycle cools the box to the set temperature.
4. Then the digital thermostat will display box temperature.
5. The temperature control will cycle the compressor, evaporator fan motor and condenser fan motor to maintain box temperature at the control setting. For more information see R290 Evaporator Fan Operation on page 25.

R290 Refrigerator Defrost

The temperature control also monitors the evaporator temperature and will turn off the compressor and condenser fan motor when needed to allow accumulated frost on the evaporator to clear. During this defrost cycle, the digital temperature display will read dEF. After the defrost cycle is complete, the temperature control will return to a normal cooling cycle, but the display will continue to read dEF until the evaporator returns to normal cooling temperatures (up to 30 minutes).

R290 Freezer

Freezers are factory set at mid-range to maintain about -2°F (-19°C) box temperature.

1. At initial start-up or anytime power is disconnected, then reconnected to the unit, the control will go into defrost mode
2. The control will enter a DEFROST mode and the display will read dEF. The compressor and condenser fan as well as the evaporator fan will remain off until this initial defrost is complete. This initial defrost cycle may take up to 35 minutes to complete.
3. The display will continue to read dEF for an additional 30 minutes while the freezing cycle cools the box to the set temperature.
4. Then the thermostat will display box temperature.
5. The temperature control will cycle the compressor, evaporator fan motor and condenser fan motor to maintain box temperature at the control setting. For more information see R290 Evaporator Fan Operation on page 25.

R290 Freezer Automatic Defrost

The control also monitors compressor total running time and will enter a defrost cycle after total compressor running time is greater than seven hours since the last defrost cycle OR if evaporator coil temperature drops below -30°F (-34°C) (indicating excessive frost on the coil).

R290 Freezer Manual Defrost

If a manual defrost is desired, hold the upper left button for five seconds or unplug the unit for several seconds, then plug unit back in. This will cause the control to re-initialize and then enter a defrost cycle.

When the control enters the defrost mode, it switches off the evaporator fan motor, compressor and condenser fan motor, and switches on the defrost heater to warm the evaporator coil. Thereby melting all frost accumulated during the previous refrigeration cycle. The digital temperature display will now read dEF. The control will continue the defrost cycle for a MINIMUM of six minutes and a MAXIMUM of 35 minutes depending on the amount of frost accumulated on the evaporator coil.

After the defrost cycle is complete, the control returns to a normal refrigeration cycle, however the evaporator fan motor will not switch on until the evaporator reaches -5°F (-21°C) or two minutes AFTER the compressor and condenser fan motor have begun operating. The digital temperature display will continue to read dEF until the evaporator has returned to normal freezing temperatures (up to 30 minutes).

R290 TEMPERATURE CONTROL & DISPLAY

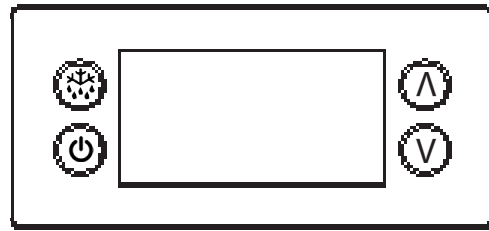

Control Display

Operation / Indication			
Status	Displayed		Comments
Normal (°C)	Temp. [°C]		Unit depends on setting (parameters in control)
Normal (°F)	Temp. [°F]		
Show set-point	Temp.		
Set to Defrost	dEF / Temp		Depends on setting (parameters in control or as chosen by upper left button)
Sensor 1 defect	E01	X	Air sensor
Sensor 2 defect	E02	X	Coil sensor
Sensor 3 defect	E03	X	Open
Sensor 4 defect	E04	X	Open
High temperature alarm	Hi	X	Automatically switching at 2 sec rate
Low temperature alarm	Lo	X	
Line voltage too high, above 140 volts	uHi	X	
Line voltage too low, below 96 volts	uLi	X	
Control calls for cooling for more than 24 hours straight	LEA	X	Time includes defrost. Error will go away if the control cycles off the compressor or if the power is shut off. If error is on a cold pan it could be related to a high ambient temperature or not shutting the rail off nightly.

All alarms sound for approximately 10 seconds and then are silent for 50 seconds. It will do that for 15 cycles and then remain silent. The alarm code will still be present on the display until the fault clears.

R290 Temperature Control & Display Operation

Press upper or lower right button.

- Display show actual set-point (blinking).
 - » If buttons untouched for 3 seconds returns to normal.
- Increase set-point by pressing upper button. Max value depends on parameters in control.
- Decrease set-point by pressing lower button. Min value depends on parameters in control.
 - » If buttons untouched for 3 seconds returns to normal and stores new set-point.

Press upper left button for 5 seconds.

- Start defrost.

Press lower left button for 5 seconds.

- Unit goes into stand-by mode.
 - » The display will read off, then a period.
- Press the lower left button again for 5 seconds.
 - » The display will read on.
 - » The unit will then start up in the defrost mode, and display will read dEF.

R290 Power Switch

All freezers, two and three refrigerators are equipped with a power disconnect switch located behind the louvered end panel. Switch must be in the on position for the unit to operate. If the switch is turned off, then returned to the on position, the unit will enter a defrost cycle and the display will read dEF.

Light Switch

GB & GBS glass door units have a light switch located behind the louvered panel next to the power switch.

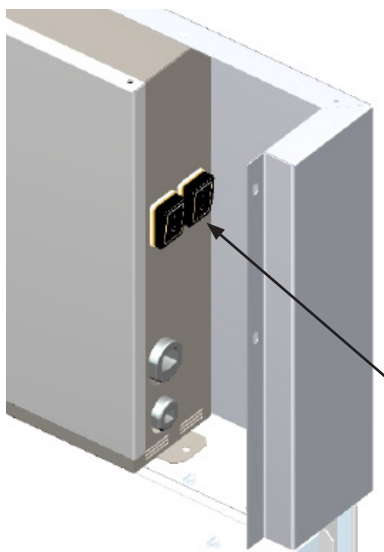

R290 Energy Saver Switch

Select freezers are equipped with an energy saver switch for service use. It is located in the electrical box behind the front shroud. It controls the length of time that heat is applied to the door perimeter. The normal operating position for this switch is the on position, providing the shortest amount of time. If excessive condensation is observed on the door opening, switch to the off position with the help of an authorized service agent. The off position will increase the length of time the door heater is on.

R290 Temperature Alarm

The alarm will sound and flash “HI” or “LO” 90 minutes after the unit has reached its alarm temperature point or after any power interruption if the temperature is above or below the alarm set points. Refrigerators are factory set at mid-range to maintain about 38°F (3°C) box temperature. The high refrigerator temperature point is 50°F (10°C). The low refrigerator temperature point is 25°F (-4°C). Freezers are factory set at mid-range to maintain about -2°F (-19°C) box temperature. The high freezer temperature point is 20°F (-7°C). Freezers do not have a low temperature point.

R290 EVAPORATOR FAN OPERATION

During normal operation the evaporator fan may cycle and/or pulse independently of the compressor. Consult Technical Support at 1-844-724-CARE if you are unsure of the proper function.

	Cooling Cycle				Defrost Cycle	
	Compressor On		Compressor Off		Compressor Off	
	Evap Fan On	Evap Fan Off	Evap Fan On	Evap Fan Off	Evap Fan On	Evap Fan Off
Refrigerator	X		Cycles On 2-Min, Off 2-Min		X	
Freezer	X			X		X

R290 CHANGING DISPLAY FROM FAHRENHEIT TO CELSIUS ON ERC112 CONTROL

1. Simultaneously hold the up and down arrows for 5 seconds to access menu for password protected parameters.



2. Screen should temporarily flash **PAS** and then move to a numeric screen.



3. Scroll to **187** using the up/down arrows and push the stand-by button (lower left button) to enter.



4. Scroll to **dis** using the up/down arrows and push the stand-by button (lower left button) to enter into the display menu.



5. Scroll to **CFu** using the up/down arrows and push the stand-by button (lower left button) to enter the display unit menu.



6. **-F** should be displayed indicating Fahrenheit. Use the down arrow to change it to **-C** for Celsius and hit the stand-by button (lower left button) to enter the change.



7. Push the defrost button (upper left button) to move out of the display unit menu.

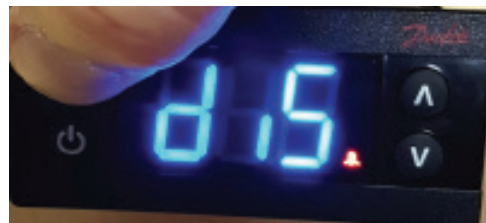

8. Push the defrost button (upper left button) to move out of the display menu and back to the normal display.

NOTE: For steps 7 and 8, display will return back to normal display after 30 seconds of inactivity.



Section 4 Maintenance

! DANGER

It is the responsibility of the equipment owner to perform a Personal Protective Equipment Hazard Assessment to ensure adequate protection during maintenance procedures.

! DANGER

Failure to disconnect the power at the main power supply disconnect could result in serious injury or death. The power switch DOES NOT disconnect all incoming power.

! DANGER

Disconnect electric power at the main power disconnect for all equipment being serviced. Observe correct polarity of incoming line voltage. Incorrect polarity can lead to erratic operation.

⚠ Warning

Never use sharp objects or tools to remove ice or frost. Do not use mechanical devices or other means to accelerate the defrosting process.

Cleaning and Sanitizing Procedures

⚠ Caution

Maintenance and servicing work other than cleaning as described in this manual must be done by an authorized service personnel.

GENERAL

⚠ Warning

When using cleaning fluids or chemicals, rubber gloves and eye protection (and/or face shield) must be worn.

You are responsible for maintaining the equipment in accordance with the instructions in this manual. Maintenance procedures are not covered by the warranty.

Maintenance	Daily	Weekly	Monthly	After Prolonged Shutdown	At Start-Up
Interior	X			X	X
Gasket	X			X	X
Exterior	X			X	X
Drain		X		X	X
Condenser Coil			X	X	X
Casters			X	X	X

INTERIOR CLEANING**Notice**

When cleaning interior and exterior of unit, care should be taken to avoid the front power switch and the rear power cord. Keep water and/or cleaning solutions away from these parts.

Notice

Never use a high-pressure water jet for cleaning or hose down or flood interior or exterior of units with water. Do not use power cleaning equipment, steel wool, scrapers or wire brushes on stainless steel or painted surfaces.

The interior can be cleaned using soap and warm water. If this isn't sufficient, try ammonia and water or a nonabrasive liquid cleaner.

EXTERIOR CLEANING**Notice**

Never use an acid based cleaning solution on exterior panels! Many food products have an acidic content, which can deteriorate the finish. Be sure to clean the stainless steel surfaces of ALL food products.

Clean the area around the unit as often as necessary to maintain cleanliness and efficient operation.

Wipe gasket and surfaces with a damp cloth rinsed in water to remove dust and dirt from the outside of the unit. Always rub with the "grain" of the stainless steel to avoid marring the finish. If a greasy residue persists, use a damp cloth rinsed in a mild dish soap and water solution. Wipe dry with a clean, soft cloth.

Never use steel wool or abrasive pads for cleaning. Never use chlorinated, citrus based or abrasive cleaners.

Stainless steel exterior panels have a clear coating that is stain resistant and easy to clean. Products containing abrasives will damage the coating and scratch the panels. Daily cleaning may be followed by an application of stainless steel cleaner which will eliminate water spotting and fingerprints. Early signs of stainless steel breakdown are small pits and cracks. If this has begun, clean thoroughly and start to apply stainless steel cleaners in attempt to restore the steel.

DRAIN

Each unit has a drain located inside the unit that removes the condensation from the evaporator coil and routes it to an external condensate evaporator pan. Each drain can become loose or disconnected during normal use. If you notice water accumulation on the inside of the unit, be sure the drain tube is connected to the evaporator drain pan. If water is collecting underneath the unit, make sure the end of the drain tube is in the condensate evaporator. The leveling of the unit is important as the units are designed to drain properly when level. Be sure all drain lines are free of obstructions.

CLEANING THE CONDENSER COIL

In order to maintain proper refrigeration performance, the condenser fins must be cleaned of dust, dirt and grease regularly. It is recommended that this be done monthly. If conditions are such that the condenser is totally blocked in a month, the frequency of cleaning should be increased. Clean the condenser with a vacuum cleaner or stiff brush. If extremely dirty, a commercially available condenser cleaner may be required.

Failure to maintain a clean condenser coil can initially cause high temperatures and excessive run times. Continuous operation with a dirty or clogged condenser coil can result in compressor failure. Neglecting the condenser coil cleaning procedures will void any warranties associated with the compressor and cost to replace the compressor.

CASTERS

Wipe casters with a damp cloth monthly to prevent corrosion.

DOORS/HINGES

Over time and with heavy-use doors, the hinges may become loose. If this happens, tighten the screws that mount the hinge brackets to the frame of the unit. Loose or sagging doors can cause the hinges to pull out of the frame, which may damage both the doors and the hinges. In some cases this may require qualified service agents or maintenance personnel to perform repairs.

PREVENTING BLOWER COIL CORROSION

To help prevent corrosion of the blower coil, store all acidic items, such as pickles and tomatoes, in seal-able containers. Immediately wipe up all spills.

THIS PAGE INTENTIONALLY LEFT BLANK

Section 5 Troubleshooting

Problem -> Cause -> Correction Chart

Problem	Cause	Correction
Cabinet not running	Fuse blown or circuit breaker tripped.	Replace fuse or reset circuit breaker.
	Power cord unplugged.	Plug in power cord.
	Thermostat set too high.	Set thermostat to lower temperature.
	Main power switch turned off.	Turn main power switch on.
	Cabinet in defrost cycle. (Freezer models)	Wait for defrost cycle to finish.
Condensing unit runs for long periods or continuously	Excessive amount of warm product placed in cabinet.	Allow adequate time for product to cool down.
	Prolonged door openings or door(s) ajar.	Make sure door(s) are closed when not in use. Avoid prolonged door openings.
	Door gasket(s) not sealing properly.	Check gasket condition. Adjust door or replace gasket if necessary.
	Dirty condenser coil.	Clean the condenser coil.
	Evaporator coil iced over.	Turn unit off and allow coil to defrost. Make sure thermostat is not set too cold. Also, check gasket condition.
Cabinet temperature is too high	Thermostat set too high.	Set thermostat to lower temperature.
	Poor air circulation in cabinet.	Re-arrange product to allow proper air circulation.
	Exterior thermometer is out of calibration.	Re-calibrate thermometer.
	Excessive amount of warm product placed in cabinet.	Allow adequate time for product to cool down.
	Prolonged door openings or door(s) ajar.	Make sure door(s) are closed when not in use. Avoid prolonged door openings.
	Dirty condenser coil.	Clean the condenser coil.
	Evaporator coil iced over.	Turn unit off and allow coil to defrost. Make sure thermostat is not set too cold. Also, check gasket condition.
Cabinet is noisy	Loose part(s).	Locate and tighten loose part(s).
Refrigerator is freezing product	Thermostat is set too low.	Set thermostat to higher temperature.
	Dirty condenser coil.	Clean the condenser coil.
	Not enough cabinet clearance for proper refrigeration system operation.	Move cabinet or make other adjustments to gain proper cabinet clearances.
Compressor will not start	Low voltage to cabinet.	Check and correct incoming voltage to cabinet.
Temperature display reads E1	Box temperature sensor circuit is either open or shorted.	Check resistance of sensor for open or short and replace sensor if either condition is found. If not, replace control.
Temperature display reads E2	Coil temperature sensor circuit is either open or shorted.	Check resistance of sensor for open or short and replace sensor if either condition is found. If not, replace control.
Temperature display reads E6	Control has a defective potentiometer.	Replace control.
Temperature display reads E13	Communication error between controller and display.	Check for loose plugs on cable from control to display. If there are no loose plugs the display or control may need to be replaced.



DELFIELD
980 SOUTH ISABELLA ROAD, MOUNT PLEASANT, MI 48858
800-733-8821
WWW.DELFIELD.COM



Welbilt offers fully-integrated kitchen systems and our products are backed by KitchenCare® aftermarket parts and service. Welbilt's portfolio of award-winning brands includes **Cleveland™**, **Convotherm®**, **Crem®**, **Delfield®**, **fitkitchen®**, **Frymaster®**, **Garland®**, **Kolpak®**, **Lincoln®**, **Manitowoc®**, **Merco®**, **Merrychef®** and **Multiplex®**.

Bringing innovation to the table • **welbilt.com**