

# 4460NP Mega Top

Front-Breathing Self-Contained Mega Top Refrigerated Bases

4460NP Mega Top

## Models

- |               |  |
|---------------|--|
| • 4460NP-12M  | Two section with doors, twelve pan capacity        |
| • D4460NP-12M | Two section with drawers, twelve pan capacity      |
| • 4460NP-18M  | Two section with doors, eighteen pan capacity      |
| • D4460NP-18M | Two section with drawers, eighteen pan capacity    |
| • 4460NP-24M  | Two section with doors, twenty-four pan capacity   |
| • D4460NP-24M | Two section with drawers, twenty-four pan capacity |

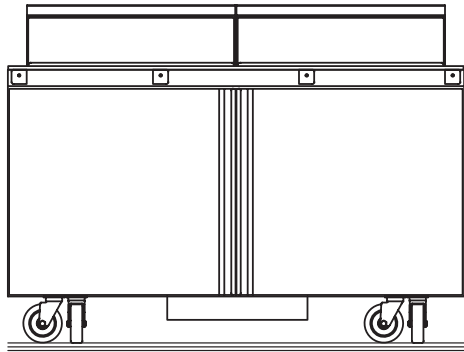

4460NP-24M

## Standard Features

- Patented air screen ensures product stays cold without drying it out
- All 4400 Series units are 100% front breathing, which allows the unit to be pushed against a wall or built into a cabinet or an existing line up
- Durable, rugged stainless steel sides, top and front
- Features Delfield's exclusive ABS interior (on sides). ABS is extremely durable - it won't dent, chip or corrode and is backed by a limited lifetime warranty
- Delfield supplies 1/6 size pans and positive placement adapter bars for top opening
- Dual level pan brackets allow the pans to be lowered an additional inch in the unit without tools to provide additional pan temperature holding performance
- Mega top refrigerators are standard with 8" wide, dishwasher safe polyethylene cutting board mounted on heavy-duty brackets
- "D" prefix models feature Delfield's new drawer system. Drawers are backed by a 10-year warranty on the track assembly
- Environmentally friendly R290 refrigerant
- High density foamed in place environmentally friendly, Kyoto Protocol Compliant, Non ODP (Ozone Depletion Potential), Non GWP (Global Warming Potential) polyurethane keeps energy costs low
- Bent in full length handle
- Standard on 5" casters for easy cleaning and installation
- 10' cord and plug supplied
- One epoxy coated wire shelf standard, installed per door section
- ACT solid state electronic control
- Three year parts and labor warranty and an additional two year compressor parts warranty

## Options & Accessories

- Various lid options
- 18" wide single tier overshelf
- Stainless steel finish on back
- Plastic laminate on front
- Additional wire shelves
- 3" casters, 4" ride height
- Door lock
- Exterior thermometer

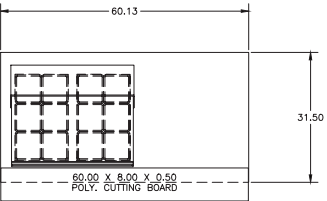
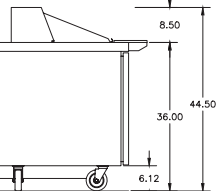
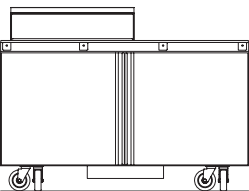
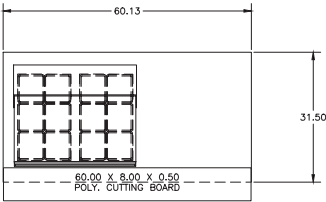
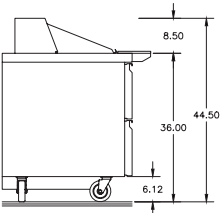
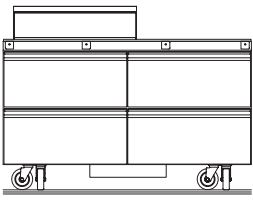
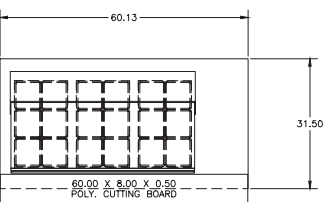
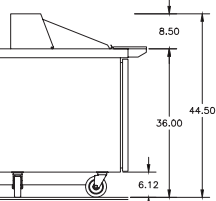
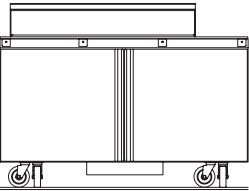
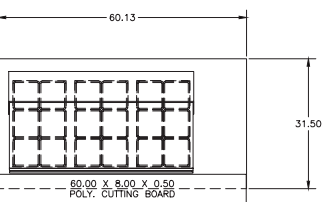
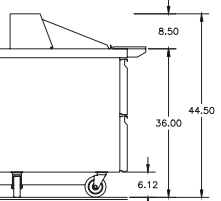
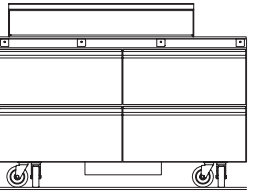
4460NP-12M	D4460NP-12M
<p>4460NP-12M Pan Cutout Configuration</p>  <p>4460NP-12M Right Side View</p>  <p>4460NP-12M Elevation View</p> 	<p>D4460NP-12M Pan Cutout Configuration</p>  <p>D4460NP-12M Right Side View</p>  <p>D4460NP-12M Elevation View</p> 
4460NP-18M	D4460NP-18M
<p>4460NP-18M Pan Cutout Configuration</p>  <p>4460NP-18M Right Side View</p>  <p>4460NP-18M Elevation View</p> 	<p>D4460NP-18M Pan Cutout Configuration</p>  <p>D4460NP-18M Right Side View</p>  <p>D4460NP-18M Elevation View</p> 

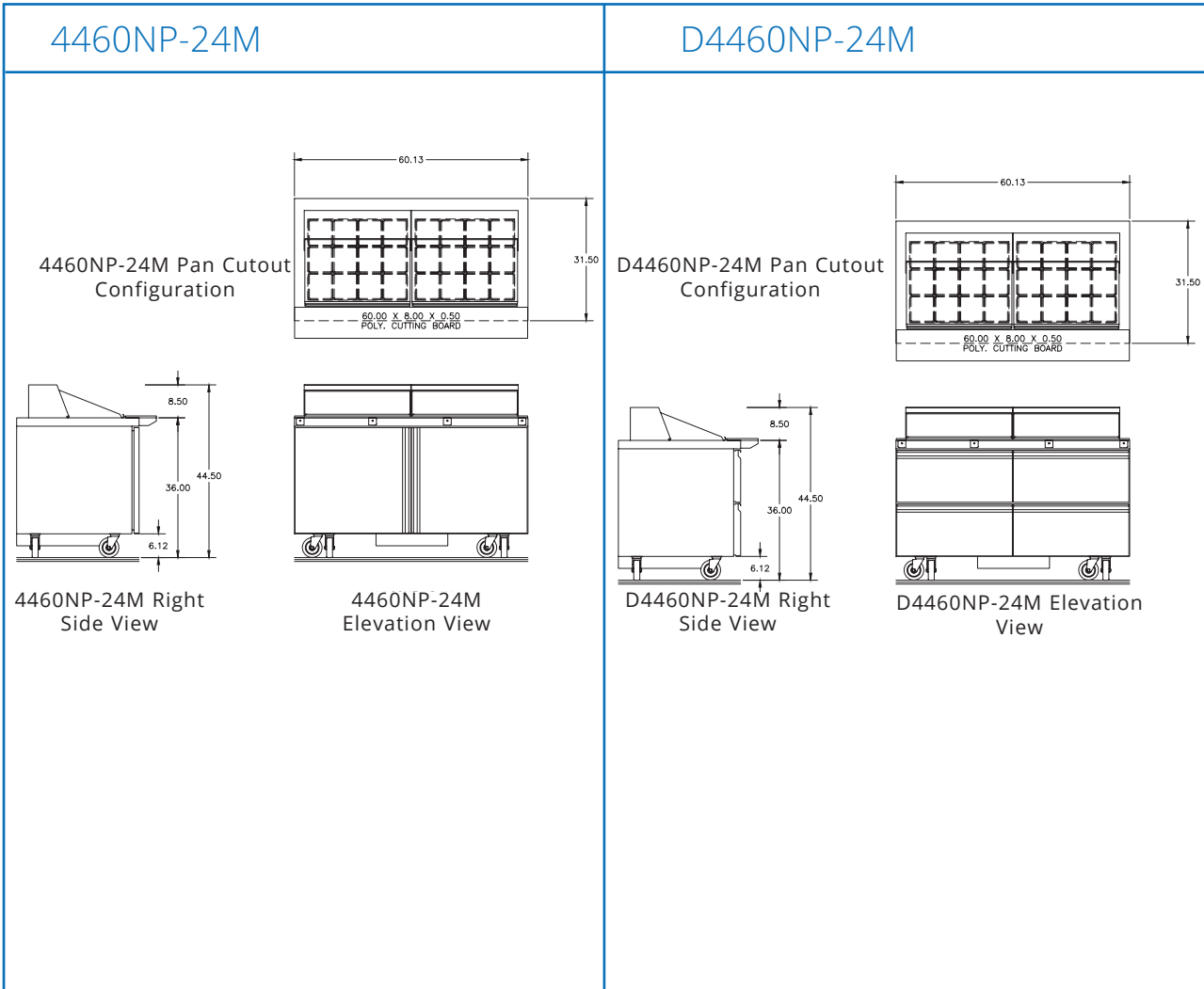

**INSTALLATION NOTE:**

Refrigeration system is designed so that air will flow under the unit, through the compressor area and out the front of the unit. Any restriction to this air flow path will void the warranties.

### 4460NP Mega Top

Specifications									
Model	1/6 Size Pan Cap.	# of Shelves	Shelf Area	Volume	h.p.	V/Hz/Ph	Amps	nema plug	Ship Weight
4460NP-12M	12	2	7.19ft <sup>2</sup>	20.20ft <sup>3</sup>	.35	115/60/1	6.0	5-15P	411lbs/186kg
D4460NP-12M	12	N/A	N/A	20.20ft <sup>3</sup>	.35	115/60/1	6.0	5-15P	495lbs/225kg
4460NP-18M	18	2	7.19ft <sup>2</sup>	20.20ft <sup>3</sup>	.35	115/60/1	6.0	5-15P	411lbs/186kg
D4460NP-18M	18	N/A	N/A	20.20ft <sup>3</sup>	.35	115/60/1	6.0	5-15P	495lbs/225kg
4460NP-24M	24	2	7.19ft <sup>2</sup>	20.20ft <sup>3</sup>	.35	115/60/1	6.0	5-15P	411lbs/186kg
D4460NP-24M	24	N/A	N/A	20.20ft <sup>3</sup>	.35	115/60/1	6.0	5-15P	495lbs/225kg

## Specifications

**Exterior top** is one-piece 22-gauge stainless steel with integral 2.12" (5.4cm) square nosing on the front. Telescoping lid is constructed of 20-gauge stainless steel. Top of drawer unit has openings to accept 12, 18 or 24 1/6 size plastic pans 4" (10cm) deep. Top of door unit has openings to accept 12, 18 or 24 1/6 size plastic pans 4" or 6" (10cm or 15cm) deep. Adapter bars and 1/6 size pans are supplied by Delfield. Temperature in top openings maintains 33°F (1°C) to 41°F (5°C), with pans recessed 2.5" (6.4cm) at 86°F ambient room temperature, meeting NSF 7 requirements. One 60" x 8" x .5" (152.4cm x 20.3cm x 1.3cm) polyethylene cutting board is mounted on the top at the front edge.

**Dual level pan brackets** allow the pans to be lowered an additional inch in the unit without tools to provide additional pan temperature holding performance.

**Exterior back and bottom** are two-piece 24-gauge galvanized steel. Exterior ends are stainless steel.

**Interior sides** are thermoformed ABS plastic with shelf supports. Base is fully insulated with high-density foamed in place environmentally friendly, Kyoto Protocol Compliant, Non ODP (Ozone Depletion Potential), Non GWP (Global Warming Potential) polyurethane.

**Refrigeration system** uses R290 refrigerant. Compressor is .35 H.P., with condenser coil and hot gas condensate evaporator mounted on rear of the cabinet. Evaporator coil is located on the interior rear wall of the cabinet. Refrigerant flow is controlled by a capillary tube. Cabinet maintains an interior cabinet temperature of 36°F to 40°F (2°C to 4°C).

**ACT control:** ACT electronic, solid state control, mounted on the exterior rear of the cabinet, allows unit to maintain precise temperatures in heavy duty conditions.

**Electrical connections** are 115 volt, 60 Hertz, single phase. Unit has a 10' (1.8m) long electrical cord and NEMA 5-15P plug.

**Casters:** Equipment is mounted on 5" (13cm) diameter plate casters with front two locking. Equipment clearance above the floor is 2.5" (6cm).

**Doors** have a 22-gauge stainless steel exterior, with thermoformed ABS plastic interior liner. Cabinet has one adjustable epoxy-coated wire shelf per door opening.

**Drawers** have 22-gauge stainless steel exterior with thermoformed ABS plastic interior liner. Drawer frames are 12-gauge stainless steel. Drawer slides are 11-gauge stainless steel with Delrin bearings. Each top drawer holds one 12" x 20" (30.5cm x 50.8cm) pan, three 1/9 size and three 1/6 size 4"-6" (10.2cm-15.2cm) deep pans. Each bottom drawer holds one 12" x 20" (30.5cm x 50.8cm) pan, three 1/9 size and three 1/6 size 4" (10.2cm) deep pans. Pans are supplied by others.

4460NP Mega Top



Welbilt reserves the right to make changes to the design or specifications without prior notice.