

CHEF BASES (FOUR DRAWER)

Side Mounted Condensing Unit

ECB - Series • ECB72D4 • ECB82D4 • ECB82-84D4 • ECB82-86D4 • ECB96D4

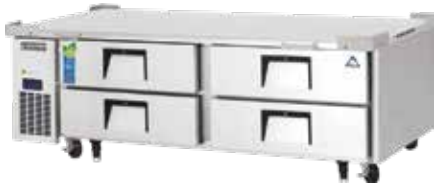

▲ ECB72D4



▲ ECB82D4



▲ ECB82-84D4



▲ ECB82-86D4



▲ ECB96D4

Cabinet Construction

- Heavy duty stainless steel interior / exterior with rounded corners for a hazard-free workspace.
- Galvanized steel bottom and rear.
- 2.5" thick high density polyurethane insulation.
- 16-gauge stainless steel worktop is built with unique air chamber and vents that channel heat produced by mounted cooking equipment away from the unit. Additional layer of high grade insulation material withstands extreme heat. These features prevent the worktop from heat-induced warping, keep the cabinet cold and reduce overall energy costs.
- Thick gauge stainless steel corner guards keep mounted cooking equipment from sliding off the worktop.
- Heavy duty stainless steel grips provide secure maneuverability for the unit.
- 12-gauge metal caster brackets support additional weight of mounted cooking equipment.
- Six 5" swivel casters with locks on front set. Three front leg stabilizers standard for all models.

Temperature Control

- Multi-function digital controller with easy to read LED display.
- Factory preset temperature, 35°F. Temperature setting range from 33°F to 54°F.
- Audible overheat protection alarm for compressor and condenser coil.

Recommended Operating Conditions

- A minimum clearance of 6" is required between the cooking equipment's heating element and the Chef Base worktop.

Options

- 3" swivel casters with locks.
- 3.5" – 6" height-adjustable and interchangeable legs.

Refrigeration System

- Side mounted, self-contained and fully detachable Blizzard R290 condensing unit uses environmentally friendly, EPA-compliant R290 refrigerant with zero (0) Ozone Depletion Potential (ODP) and three (3) Global Warming Potential (GWP). Blizzard R290 is easily replaceable and requires no on-site brazing.
- Electronically commutated (ECM) fan motors achieve rapid cooling with less energy consumption.
- Full-length air duct system ensures optimal circulation of cold air.
- Time-initiated and temperature-terminated auto defrost cycle for seamless operation.
- Large capacity, corrosion-resistant condenser and evaporator coils.
- Self-maintaining, energy-efficient condensate drain pan requires no external drains or electric heaters.
- High performance, auto-reverse condenser fan motor supports compressor ventilation and condenser coil cleaning. Refer to owner's manual for full maintenance instructions.
- Pressure relief devices allow smooth access to cabinet interior when re-opening drawers.
- Pre-wired and ready to plug, 115V/60Hz/1Ph, NEMA 5-15P.

Drawers

- Heavy duty stainless steel interior / exterior.
- 2.5" thick high density polyurethane insulation.
- Thick gauge, stainless steel drawer frames with low-friction ball bearings.
- Snap-in, heat resistant, magnetic drawer gaskets make cleaning and replacement an easy process.
- High strength, recessed drawer handles.
- NSF certified polycarbonate 4" deep pans (refer to the website for pan configurations).



Dimensions

Side View

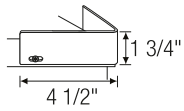

Corner Guards

Durable stainless steel corner guards mounted on the top surface prevent cooking equipment from accidentally sliding off the unit.

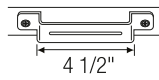

Stainless Steel Grips

Heavy duty stainless steel top surface grips for easy and safe maneuverability of the unit.

ABS Legs



Two additional front adjustable stainless steel clad ABS legs to provide extra stability when opening, closing doors and weight support.



Equipped with 9 ft long NEMA 5-15P plug.

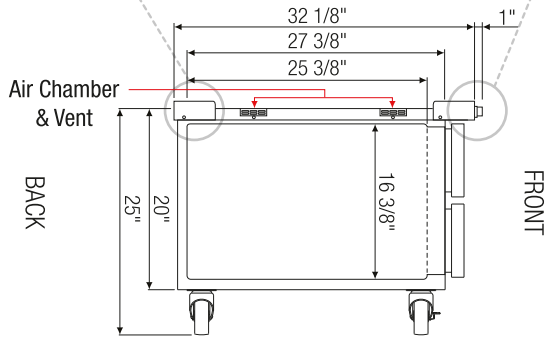

Air Flow

Front view of cabinet interior demonstrates air circulation from left to right.

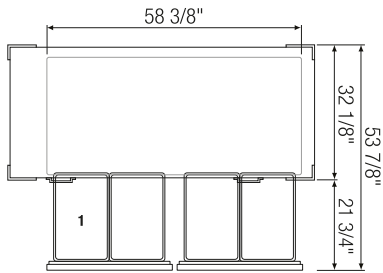
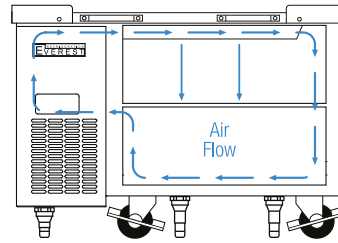

▲ ECB72D4

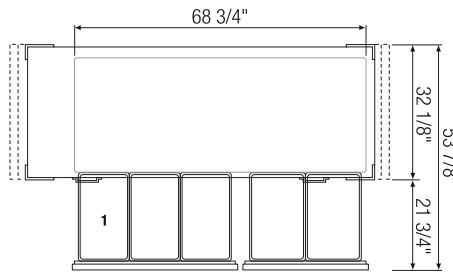

▲ ECB82D4 • ECB82-84D4 • ECB82-86D4

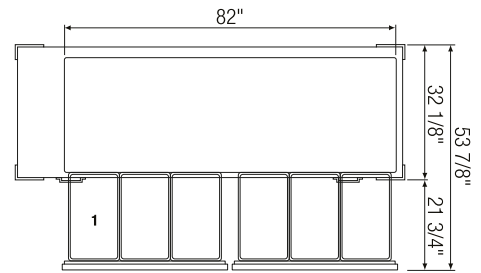

▲ ECB96D4

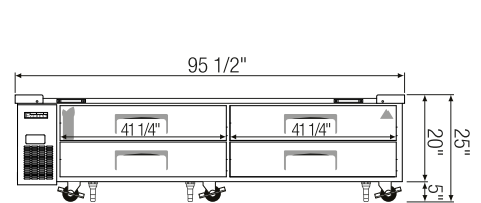
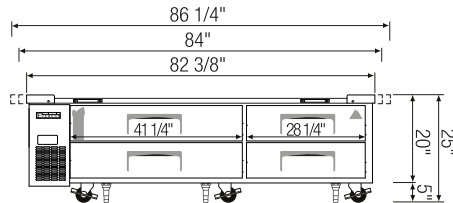
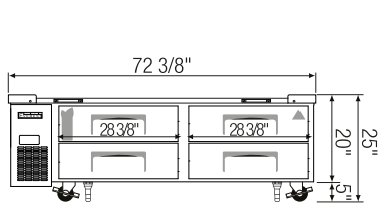

Model	Ref/ Frz/ Dual	# of Drawers	Max. Weight Support Capacity (LBS)	HP	Refrigerant	# of Pans	BTU/HR †	Power (V-Hz-Ph)	Amps	Crated Weight (LBS)	Exterior Dimensions (Inches)		
											L	D ^a	H [*]
ECB72D4	Ref	4	1,084	1/4+	R-290	1 x 8	1,926	115-60-1	3.50	421	72 3/8	32 1/8	20
ECB82D4	Ref	4	1,084	1/3	R-290	1 x 10	2,311	115-60-1	2.50	484	82 3/8	32 1/8	20
ECB82-84D4	Ref	4	1,084	1/3	R-290	1 x 10	2,311	115-60-1	2.50	489	84	32 1/8	20
ECB82-86D4	Ref	4	1,084	1/3	R-290	1 x 10	2,311	115-60-1	2.50	494	86 1/4	32 1/8	20
ECB96D4	Ref	4	1,434	1/3	R-290	1 x 12	2,311	115-60-1	2.50	567	95 1/2	32 1/8	20

*: Height does not include 5" for casters.

†: Based on evaporating temperature of 23°F (-5°C) & condensing temperature of 131°F (55°C).

a: Depth does not include 1" for stainless steel grip.

Ref = Refrigerator

Specifications subject to change without notice.

Product dimensions are for general purposes and not absolute value. Product capacity (♣) is calculated based on standard industry figures. Slight variations may exist. If dimensions and capacity are critical, please contact Everest Refrigeration.



Please visit our website for updated Energy Efficiency information.