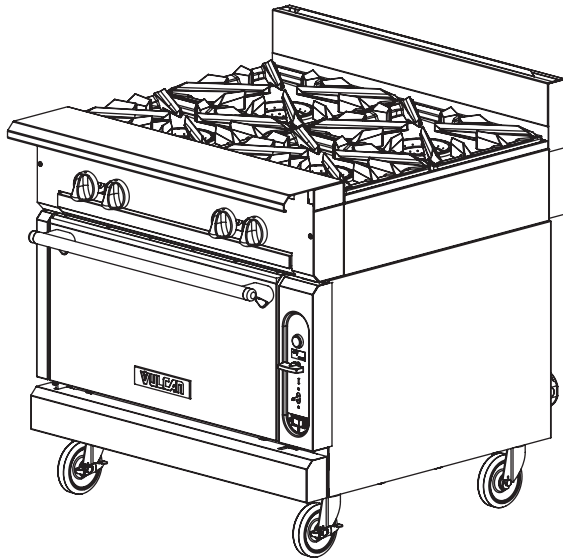

HEAVY DUTY COOKING**VULCAN****HEAVY DUTY GAS RANGE
4-BURNERS / 36" WIDE GAS RANGE****Model V4B36C**

shown on a convection oven base

**SPECIFICATIONS**

36" wide heavy duty gas range, Vulcan Model No. V4B36 (modular) and V4B36B (cabinet base) or V4B36S (standard oven base) and V4B36C (convection oven base). Modular construction for ease of installation. Stainless steel front, plate ledge, front top ledge with pull-out condiment rails, sides, base, stub back and 6" adjustable legs on all "B", "S", & "C" models. Stainless steel extra deep crumb tray. Four 35,000 BTU/hr. cast burners with lift-off burner heads. Individual pilots and controls for each burner. Heavy duty cast burner grates, easy lift-off 11" x 17" in front, 14" x 17" in rear. Grates are separate from aeration bowl for ease of cleaning. **Standard Oven:** 50,000 BTU/hr. with porcelain oven bottom, sides and indoor panel. **Convection Oven:** 32,000 BTU/hr. with porcelain oven bottom, sides and interior door panel (115v-1 phase blower motor, 4 amps, 6' cord and plug). Oven measures 27"w x 27"d x 13"h. Standard oven thermostat adjusts from 150°F – 550°F. Convection oven adjusts from 175°F – 550°F and the optional finishing oven for standard ovens adjusts from 300°F – 650°F. Standard oven supplied with one rack, convection oven with two racks. Both ovens allow for three rack positions. Oven door is heavy duty with counter weight door hinges. 1 1/4" diameter front gas manifold and 1 1/4" rear gas connection, capped. Total input 140,000 BTU/hr.

Exterior Dimensions:

36 3/4"d x 36"w x 36"h on 6" adjustable legs

- V4B36** 4-Burners / Modular
- V4B36B** 4-Burners / Cabinet Base
- V4B36S** 4-Burners / Standard Oven
- V4B36C** 4-Burners / Convection Oven

STANDARD FEATURES

- Stainless steel front, front top ledge, burner box, sides, base, and stub back
- 1 1/4" diameter front gas manifold with 1 1/4" rear gas connection (capped)
- 35,000 BTU/hr. open top burners with lift off heads
- 50,000 BTU/hr. standard oven burner
- 32,000 BTU/hr. convection oven burner
- Porcelain oven cavity
- Individual pilots and controls for each burner
- Heavy-duty cast grates
- 4" stainless steel stub riser
- 6" adjustable stainless steel legs for "S", "C", and "B" models (no legs for modular model)
- Stainless steel cabinet base door
- Universal rack guides, one removable shelf (cabinet base)
- One year limited parts and labor warranty

OPTIONAL FEATURES (Factory Installed)

- Cap and cover front manifold
- Stainless steel oven cavity
- 650°F oven thermostat and steel hearth ("S" models)
- Fan cooling package ("C" models)
- 4" adjustable flanged feet for modular models
- Less legs for dolly mounting for "S", "C", and "B" models
- 3" high toe base for curb mounting
- Common condiment type, telescoping plate rails

ACCESSORIES (Packaged & Sold Separately)

- 3/4", 1", or 1 1/4" gas pressure regulator (specify gas type – pack loose)
- Set of 4 casters, 6" high (two locking)
- 6" adjustable flanged feet for "S", "C", and "B" models
- Extra removable shelves for use with Universal rack guides (for cabinet base)
- Banking strip
- Common condiment type, telescoping plate rails (starting at 24" length)
- 10", 22", or 34" high back risers (no shelf)
- 22" single deck solid or flo-thru high shelf risers
- 34" double deck solid or flo-thru high shelf risers
- Dolly frames
- Flexible gas hose - quick disconnect & restraining device

VULCAN

a division of ITW Food Equipment Group LLC

P.O. Box 696 ■ Louisville, KY 40201 ■ Toll-free: 1-800-814-2028 ■ Local: 502-778-2791 ■ Quote & Order Fax: 1-800-444-0602



HEAVY DUTY GAS RANGE

4-BURNERS / 36" WIDE GAS RANGE

INSTALLATION INSTRUCTIONS

1. A properly sized gas pressure regulator suitable for battery or single unit application must be furnished and installed. Natural gas 6.0" W.C., propane gas 10.0" W.C.
2. An adequate ventilation system is required for commercial cooking equipment. Information may be obtained by writing to the National Fire Protection Association, 1 Batterymarch Park, Quincy, MA 02269, www.NFPA.org. When writing, refer to NFPA No. 96.
3. These units are manufactured for installation in accordance with ANSZ223.1A (latest edition), National Fuel Gas Code. Copies may be obtained from The American Gas Association, 400 N Capitol St. NW, Washington, DC 20001, www.AGA.org.
4. **Clearances**

	Rear	Sides
Combustible	10"	10"
Non-combustible	0"	0"
5. For proper combustion, install equipment on adjustable legs or casters. On curb or platform, allow 3½" front overhang. Toe base with leveling bolts are required for curb installation. Specify when ordering.
6. Cannot be battered with GH series equipment.
7. This appliance is manufactured for commercial installation only and is not intended for home use.

NOTE: In line with its policy to continually improve its product, Vulcan reserves the right to change materials and specifications without notice.

**Specify type of gas when ordering.
Specify altitude when above 2,000 feet.**

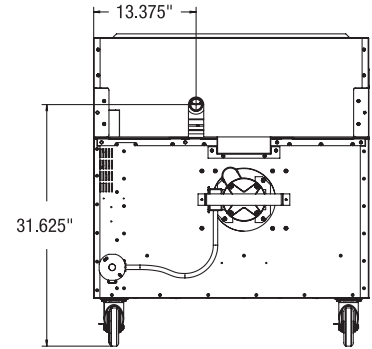
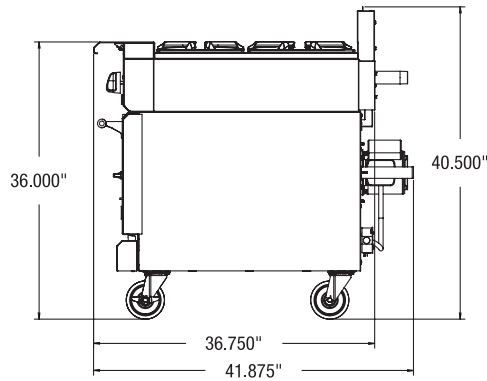
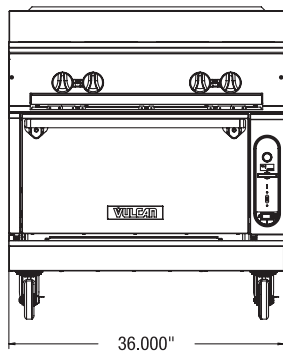
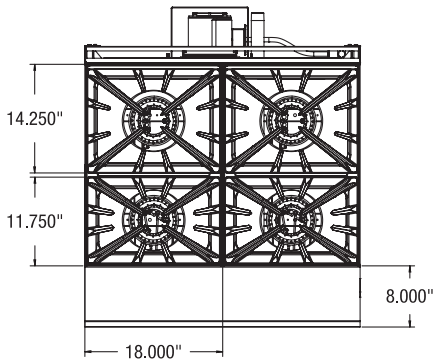

TOP CONFIGURATION	MODEL NUMBER	DESCRIPTION	TOTAL INPUT BTU / HR	SHIPPING WEIGHT LBS / KG
	V4B36	4-Burners / Modular	140,000	261 / 119
	V4B36B	4-Burners / Cabinet Base	140,000	380 / 171
	V4B36S	4-Burners / Standard Oven Base	190,000	675 / 304
	V4B36C	4-Burners / Convection Oven Base	172,000	715 / 322

This appliance is manufactured for commercial use only and is not intended for home use.



a division of ITW Food Equipment Group LLC

P.O. Box 696 ■ Louisville, KY 40201 ■ Toll-free: 1-800-814-2028 ■ Local: 502-778-2791 ■ Quote & Order Fax: 1-800-444-0602

NOTE: In line with its policy to continually improve its products, Vulcan reserves the right to change materials and specifications without notice.