



ELEVATION SERIES CUBE ICE MAKER

CIM0520/O525/O526



Model:

- CIM0520
- CIM0525
- CIM0526



CIM0520 ON B42

Features and Benefits

- 22.25" (565 mm) wide space-saving design.
- Produces up to 586 lbs (266 kg) of ice per day.
- **Energy and Environment**
 - Exceeds new 2018 DOE (Department of Energy) regulations.
 - Up to 20% more energy efficient than other models.
 - Environmentally friendly, including BPA-free plastic and recyclable parts.
- **Sanitation**
 - Plastic Food Zone eliminates hard-to-clean nooks and crannies, allowing for effortless wipe down and easy, long-lasting sanitation.
 - Built in Agion® ensures unbeatable antimicrobial protection.
 - Smart LED light indicates machine status and when cleaning is required.
 - Simple, one-touch controls for sanitization and descaling.
 - BPA-free snap-in, snap-out dishwasher-safe components.
- **Unique Dual Exhaust** - Air-cooled machines are designed to discharge hot air from both the side and top of the unit, increasing installation flexibility and reducing the potential of obstructed exhaust.
- **Universal Smart Harness™** control board simplifies installation and servicing with better access, digital diagnostics, universal components and common configuration.

CIM0520/O525/O526 CUBE ICE MAKER

Ice Form

FULL CUBE DIMENSIONS	
W x D x H (in.)	7 $\frac{1}{8}$ x 7 $\frac{1}{8}$ x 7 $\frac{1}{8}$
W x D x H (mm)	22 x 22 x 22
HALF CUBE DIMENSIONS	
W x D x H (in.)	3 $\frac{1}{8}$ x 7 $\frac{1}{8}$ x 7 $\frac{1}{8}$
W x D x H (mm)	10 x 22 x 22



CUBE

Bin Chart Kits for Combining Wider Bins with Smaller Models

		ICE STORAGE BINS										
		Model No.	B25	B40	B42	B55	B110	B700	B1000	B1300	B1325	B1660
		Capacity	242 lbs (110 kg)	344 lbs (156 kg)	351 lbs (160 kg)	510 lbs (232 kg)	854 lbs (388 kg)	680 lbs (308 kg)	1,000 lbs (454 kg)	1,320 lbs (599 kg)	1,325 lbs (601 kg)	1,660 lbs (753 kg)
		Width	30 in (762 mm)	30 in (762 mm)	22 in (559 mm)	30 in (762 mm)	48 in (1,219 mm)	30 in (762 mm)	48 in (1,219 mm)	48 in (1,219 mm)	60 in (1,524 mm)	60 in (1,524 mm)
Kits	CIM0520											
	CIM0525		KBT19		Kit Not Required	KBT19	N/A					
	CIM0526											Hold Down Securement Recommended

*See Ice-O-Matic Price List for Adapter Kits to combine ice makers with most available ice/beverage dispensers.

Options & Accessories

WATER FILTERS		
Ice Machine Model	Manifold	
	System	Replacement
CIM0520	IFQ1-XL	IOMQXL (1)
CIM0525		
CIM0526		

Note: All modular cube CIM units can be installed with manufacturer approved ozone delivery systems.

Ice Maker Warranty

COMMERCIAL WARRANTY	
Ice Maker	3 YEARS parts and labor
Evaporator and Compressor	5 YEARS parts
Evaporator (when enrolled in our filter program)	7 YEARS parts and labor



ELEVATION SERIES CUBE ICE MAKER CIMO520/O525/O526

Ice-O-Matic



Ice. Pure and Simple.

Air Cooled

Please note: air-cooled units require 6" (152 mm) clearance for air intake and exhaust.

- A. Ice maker potable water in, 3/8" FPT.
- B. Ice maker water out, 3/4" FPT.
- C. Hole for electrical connections, 7/8".
- D. Electrical connection junction box, 7/8".

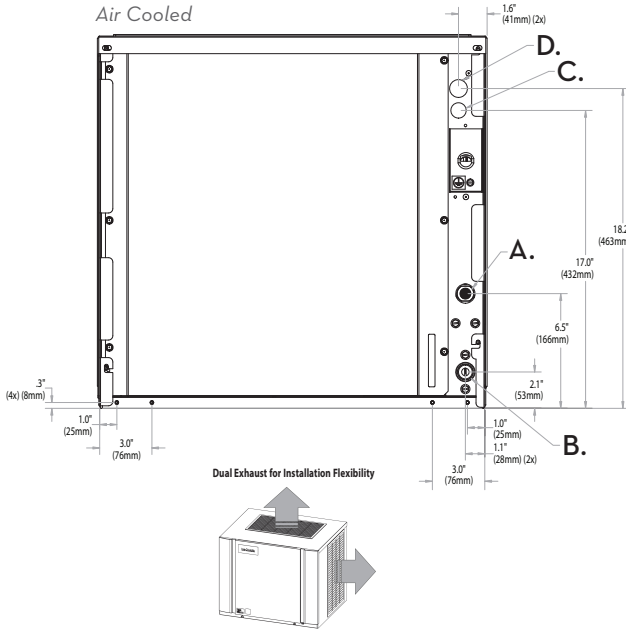

Water Cooled

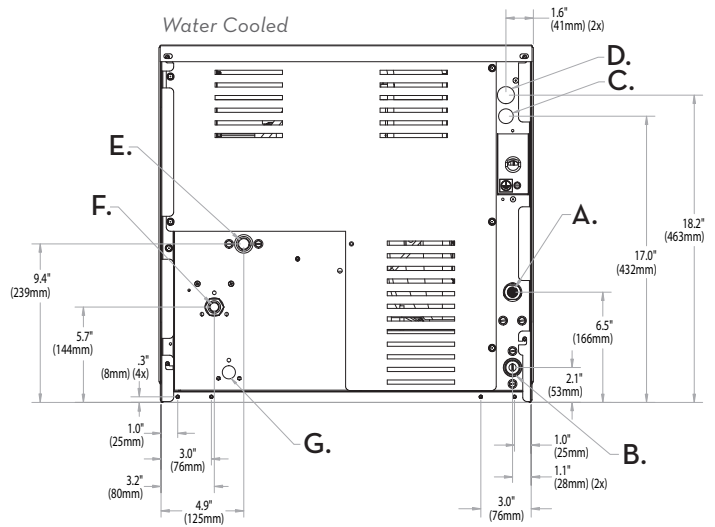

Water Cooled

- A. Ice maker potable water in, 3/8" FPT.
- B. Ice maker water out, 3/4" FPT.
- C. Hole for electrical connections, 7/8".
- D. Electrical connection junction box, 7/8" (remote).
- E. Condenser water in, 3/8" FPT (water only). Discharge line, 1/2" male quick connect coupling for precharged line set (remote only).
- F. Condenser water out, 1/2" FPT (water only).
- G. Liquid line, 3/8" male quick connect for precharged line set (remote only).

CIMO520/O525/O526 CUBE ICE MAKER

Operating Requirements

	MINIMUM	MAXIMUM	
		60 Hz	50Hz
Ambient Temp. Range Air	50°F (10°C)	100°F (38°C)	110°F (43°C)
Water Temp.	40°F (4.4°C)		
Water Pressure	20 PSIG (1.4 BAR)	80 PSIG (5.5 BAR)	

Dimensions

ALL MODELS	
W x D x H (in.)	22.25 x 24.25 x 21.25
W x D x H (mm)	565 x 616 x 540

Specifications

Model Number	Cond. Unit	Half-Cube Ice Production per 24hrs		Water Usage gallons per 100 lbs of Ice @ 90°F air/70°F water		kWH Used per 100 lbs of ice @ 90°F air/70°F water	Voltage Characteristics	Min. Circuit Ampacity	Fuse Size	Approx. BTUs per hour
		70°F air/50°F water lbs (kg)	90°F air/70°F water lbs (kg)	Potable	Condenser					
CIMO520A	Air	561 (254)	432 (196)	19.9	N/A	5.87	115/60/1	17.8	30	6,252
CIMO520W	Water	586 (266)	533 (242)	20	181	4.70		17.4		
CIMO525A	Air	529 (240)	425 (193)	20	N/A	6.11	220-240/50/1	11.2	16	
CIMO525W	Water	531 (241)	476 (216)	19.5	190	5.00		11.0		
CIMO526A	Air	555 (252)	445 (202)	20	N/A	5.02	208-230/60/1	8.2	15	

* Daily ice production based on half cube configuration. When installing a CIM on a drink dispenser, the KCUBEDISPB MUST be used.

Notes:

- Number of Wires: 3 (including ground)
- Approx. Shipping Weight lbs (kg): CIMO520A 165 (75) • CIMO520W 175 (79) • CIMO525A 165 (75) • CIMO525W 175 (79) • CIMO526A 165 (75)
- Refrigerant Type: CIMO525A - R404A



B55

Features

- Application storage capacity from 242 lbs (110 kg) to 854 lbs (388 kg).
- Multiple bin tops provide an easy solution for mounting ice makers on different sized bins.
- Polyethylene bin liner is insulated with foam for maximum ice preservation – 1.5" to 3" (38 mm to 76 mm).
- 31" deep for use where space is at a premium.
- Built-in ice scoop holders on certain models.
- Sturdy leg design – 6" (152 mm) adjustable NSF approved legs – standard.
- Durable aluminum finish.

Bin Accessories

Ice-O-Matic Part Number	Description
1011517-22	Plastic ice shovel
1011517-23	Hanging bracket for ice shovel
1011517-24	46.5" Plastic paddle
1051517-29	Hanging bracket for ice paddle
9051127-01	82 Ounce ice scoop

Single Ice Machine Configurations

Ice-O-Matic offers a full line of bins for most applications. From low profile slope-front bins to high capacity space-saving uprights, we have a bin to meet any need. The following table will help you create the system you need in a safe and cost effective manner.

Bin Model No.	Style	Application Bin Storage lbs (kgs)	Approximate Shipping Weight lbs (kgs)	CIM Series Cube Makers	ICE Series Cube Makers			Nugget Ice Makers	Flake Ice Machine
				30" (762 mm) wide	22" (559 mm) wide	30" (762 mm) wide	48" (1,219 mm) wide	21" (533 mm) wide	21" (533 mm) wide
B25PP*	Slope Front	242 (110)	74 (34)	△△	KBT19	△△	N/A	KBT19	KBT19
B40PS	Slope Front	344 (156)	103 (47)	△△	KBT19	△△	N/A	KBT19	KBT19
B42PS	Slope Front	351 (160)	99 (45)	N/A	△△	N/A	N/A	KBT24	KBT24
B55PS	Slope Front	510 (232)	125 (57)	△△	KBT19	△△	N/A	KBT19	KBT19
B110PS	Slope Front	854 (388)	163 (74)	BPF-1***	N/A	BPF-1***	△△	KBT23	KBT23

△△ Kit not required. △△** Ice clumping issues may arise. * Rotocast finish N/A Not Applicable
** ICE1506 is compatible with B700-30, B1000-48, B1300-48, B1325-60 & B1600-60. *** BPF-1 used with B110 ONLY. If you have an older model B100 bin use the KBT5.

Side-by-Side Ice Machine Configurations

There are times when it is desirable to install 2 ice machines side by side on a bin. The reasons may range from gaining maximum output to creating redundancy. Ice-O-Matic offers an array of kits and bins with custom order tops for just such applications. The following table will help you create the system you need in a safe and cost effective manner.

Bin Model No.	Style	Application Bin Storage lbs (kgs)	Approximate Shipping Weight lbs (kgs)	CIM Series Cube Makers	ICE Series Cube Makers			Nugget Ice Makers	Flake Ice Machine
				30" (762 mm) wide	Two 22" (559 mm) wide	Two 30" (762 mm) wide	Two 48" (1,219 mm) wide	Two 21" (533 mm) wide	Two 21" (533 mm) wide
B25PP*	Slope Front	242 (110)	74 (34)	N/A	N/A	N/A	N/A	N/A	N/A
B40PS	Slope Front	344 (156)	103 (47)	N/A	N/A	N/A	N/A	N/A	N/A
B42PS	Slope Front	351 (160)	99 (45)	N/A	N/A	N/A	N/A	N/A	N/A
B55PS	Slope Front	510 (232)	125 (57)	N/A	N/A	N/A	N/A	N/A	N/A
B110PS	Slope Front	854 (388)	163 (74)	N/A	N/A	N/A	N/A	KBT22	KBT22

○ Must use remote or water cooled model only. △△ Kit not required. * Rotocast finish N/A Not Applicable
○* Must use remote or water cooled model only; ice clumping issues may arise. △△** Ice clumping issues may arise.

SLOPE FRONT STORAGE BINS



Dimensions

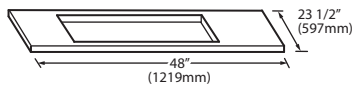
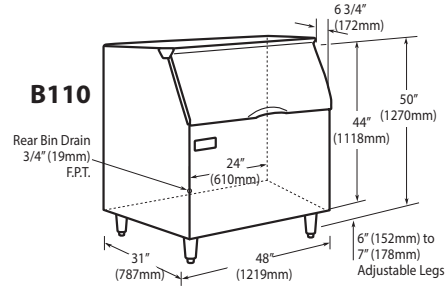
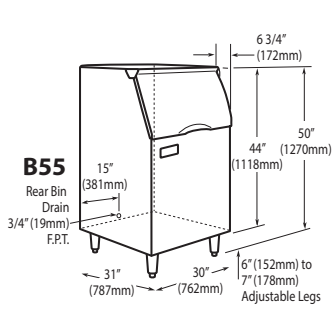
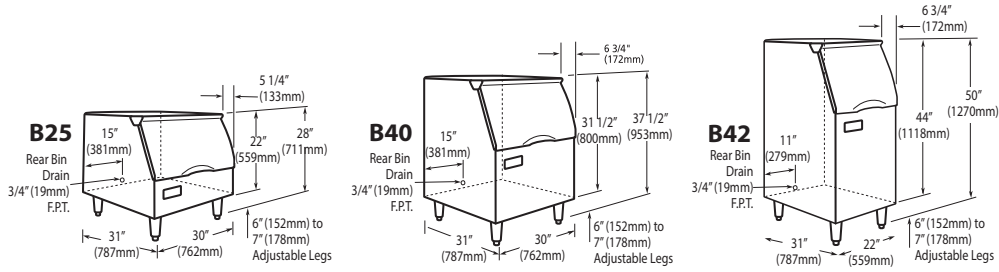

KBT5
Bin Top for 30" (762 mm) ICE series cuber including the ICE1506 family on a B100 bin

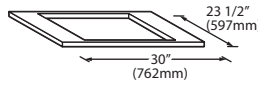

KBT19
Bin Top for 30" (762mm) bins with 22" (559mm) ICE Series Cube Ice Makers GEM Series Ice Makers & MFI Series Ice Makers

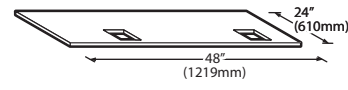

KBT22
Bin Top for 48" (1219mm) bins with (2) 21" (533mm) wide GEM Series Ice Makers & MFI Series Ice Makers

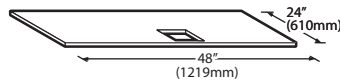

KBT23
Bin Top for 48" (1219mm) bins with (1) 21" (533mm) wide GEM Series Ice Makers & MFI Series Ice Makers

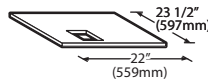

KBT24
Bin Top for 22" (559mm) bins with (1) 21" (533mm) wide GEM Series Ice Maker

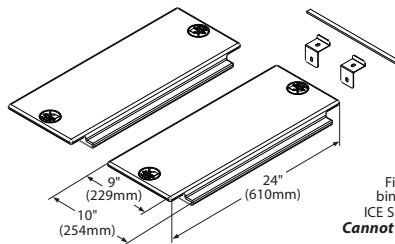

BPF-1
Filler Panel for B110 bins with 30" (762mm) ICE Series Cube Ice Makers
Cannot be used with the B100

NOTES:

Approx. Shipping Weight (lbs): B110 191 (87 kg) • B55 170 (77 kg) • B25 95 (43 kg) • B40 135 (61 kg) • B42 135 (61 kg)