



ELEVATION SERIES CUBE ICE MAKER

CIMO320/O325/O326



Model:

- CIMO320
- CIMO325
- CIMO326



CIMO320 ON B42

Features and Benefits

- 22.25" (565 mm) wide space-saving design.
- Produces up to 330 lbs (143 kg) of ice per day.
- **Energy and Environment**
 - Exceeds new 2018 DOE (Department of Energy) regulations.
 - Up to 20% more energy efficient than other models.
 - Environmentally friendly, including BPA-free plastic and recyclable parts.
- **Sanitation**
 - Plastic Food Zone eliminates hard-to-clean nooks and crannies, allowing for effortless wipe down and easy, long-lasting sanitation.
 - Built in Agion® ensures unbeatable antimicrobial protection.
 - Smart LED light indicates machine status and when cleaning is required.
 - Simple, one-touch controls for sanitization and descaling.
 - BPA-free snap-in, snap-out dishwasher-safe components.
- **Unique Dual Exhaust** - Air-cooled machines are designed to discharge hot air from both the side and top of the unit, increasing installation flexibility and reducing the potential of obstructed exhaust.
- **Universal Smart Harness™** control board simplifies installation and servicing with better access, digital diagnostics, universal components and common configuration.

CIMO320/O325/O326 CUBE ICE MAKER

Ice Form

FULL CUBE DIMENSIONS	
W x D x H (in.)	7 ⁵ / ₈ x 7 ⁵ / ₈ x 7 ⁵ / ₈
W x D x H (mm)	22 x 22 x 22
HALF CUBE DIMENSIONS	
W x D x H (in.)	3 ⁵ / ₈ x 7 ⁵ / ₈ x 7 ⁵ / ₈
W x D x H (mm)	10 x 22 x 22



CUBE

Bin Chart Kits for Combining Wider Bins with Smaller Models

ICE STORAGE BINS											
	Model No. Capacity Width	B25 242 lbs (110 kg) 30 in (762 mm)	B40 344 lbs (156 kg) 30 in (762 mm)	B42 351 lbs (160 kg) 22 in (559 mm)	B55 510 lbs (232 kg) 30 in (762 mm)	B110 854 lbs (388 kg) 48 in (1,219 mm)	B700 680 lbs (308 kg) 30 in (762 mm)	B1000 1,000 lbs (454 kg) 48 in (1,219 mm)	B1300 1,320 lbs (599 kg) 48 in (1,219 mm)	B1325 1,325 lbs (601 kg) 60 in (1,524 mm)	B1660 1,660 lbs (753 kg) 60 in (1,524 mm)
Kits	CIMO320	KBT19	Kit Not Required	KBT19	N/A	Hold Down Securement Recommended					
CIMO325											
CIMO326											

*See Ice-O-Matic Price List for Adapter Kits to combine ice makers with most available ice/beverage dispensers.

Options & Accessories

WATER FILTERS		
Ice Machine Model	Manifold	
	System	Replacement
CIMO320	IFQ1	IOMQ (1)
CIMO325		
CIMO326		

Note: All modular cube CIM units can be installed with manufacturer approved ozone delivery systems.

Ice Maker Warranty

COMMERCIAL WARRANTY	
Ice Maker	3 YEARS parts and labor
Evaporator and Compressor	5 YEARS parts
Evaporator (when enrolled in our filter program)	7 YEARS parts and labor





B55

Features

- Application storage capacity from 242 lbs (110 kg) to 854 lbs (388 kg).
- Multiple bin tops provide an easy solution for mounting ice makers on different sized bins.
- Polyethylene bin liner is insulated with foam for maximum ice preservation – 1.5" to 3" (38 mm to 76 mm).
- 31" deep for use where space is at a premium.
- Built-in ice scoop holders on certain models.
- Sturdy leg design – 6" (152 mm) adjustable NSF approved legs – standard.
- Durable aluminum finish.

Bin Accessories

Ice-O-Matic Part Number	Description
1011517-22	Plastic ice shovel
1011517-23	Hanging bracket for ice shovel
1011517-24	46.5" Plastic paddle
1051517-29	Hanging bracket for ice paddle
9051127-01	82 Ounce ice scoop

Single Ice Machine Configurations

Ice-O-Matic offers a full line of bins for most applications. From low profile slope-front bins to high capacity space-saving uprights, we have a bin to meet any need. The following table will help you create the system you need in a safe and cost effective manner.

Bin Model No.	Style	Application Bin Storage lbs (kgs)	Approximate Shipping Weight lbs (kgs)	CIM Series Cube Makers	ICE Series Cube Makers			Nugget Ice Makers	Flake Ice Machine
				30" (762 mm) wide	22" (559 mm) wide	30" (762 mm) wide	48" (1,219 mm) wide	21" (533 mm) wide	21" (533 mm) wide
B25PP*	Slope Front	242 (110)	74 (34)	△△	KBT19	△△	N/A	KBT19	KBT19
B40PS	Slope Front	344 (156)	103 (47)	△△	KBT19	△△	N/A	KBT19	KBT19
B42PS	Slope Front	351 (160)	99 (45)	N/A	△△	N/A	N/A	KBT24	KBT24
B55PS	Slope Front	510 (232)	125 (57)	△△	KBT19	△△	N/A	KBT19	KBT19
B110PS	Slope Front	854 (388)	163 (74)	BPF-1***	N/A	BPF-1***	△△	KBT23	KBT23

△△ Kit not required. △△** Ice clumping issues may arise. * Rotocast finish N/A Not Applicable

** ICE1506 is compatible with B700-30, B1000-48, B1300-48, B1325-60 & B1600-60. *** BPF-1 used with B110 ONLY. If you have an older model B100 bin use the KBT5.

Side-by-Side Ice Machine Configurations

There are times when it is desirable to install 2 ice machines side by side on a bin. The reasons may range from gaining maximum output to creating redundancy. Ice-O-Matic offers an array of kits and bins with custom order tops for just such applications. The following table will help you create the system you need in a safe and cost effective manner.

Bin Model No.	Style	Application Bin Storage lbs (kgs)	Approximate Shipping Weight lbs (kgs)	CIM Series Cube Makers	ICE Series Cube Makers			Nugget Ice Makers	Flake Ice Machine
				30" (762 mm) wide	Two 22" (559 mm) wide	Two 30" (762 mm) wide	Two 48" (1,219 mm) wide	Two 21" (533 mm) wide	Two 21" (533 mm) wide
B25PP*	Slope Front	242 (110)	74 (34)	N/A	N/A	N/A	N/A	N/A	N/A
B40PS	Slope Front	344 (156)	103 (47)	N/A	N/A	N/A	N/A	N/A	N/A
B42PS	Slope Front	351 (160)	99 (45)	N/A	N/A	N/A	N/A	N/A	N/A
B55PS	Slope Front	510 (232)	125 (57)	N/A	N/A	N/A	N/A	N/A	N/A
B110PS	Slope Front	854 (388)	163 (74)	N/A	N/A	N/A	N/A	KBT22	KBT22

○ Must use remote or water cooled model only. △△ Kit not required. * Rotocast finish N/A Not Applicable

○* Must use remote or water cooled model only; ice clumping issues may arise. △△** Ice clumping issues may arise.



SLOPE FRONT STORAGE BINS

Dimensions

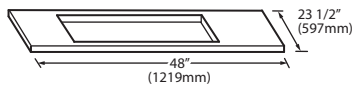
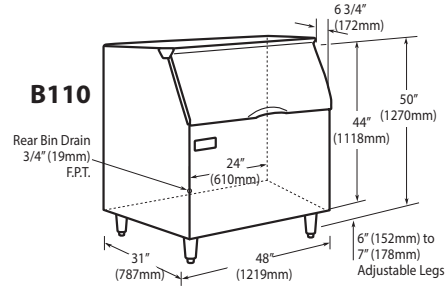
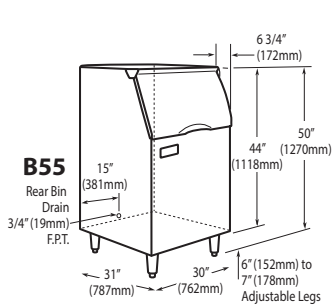
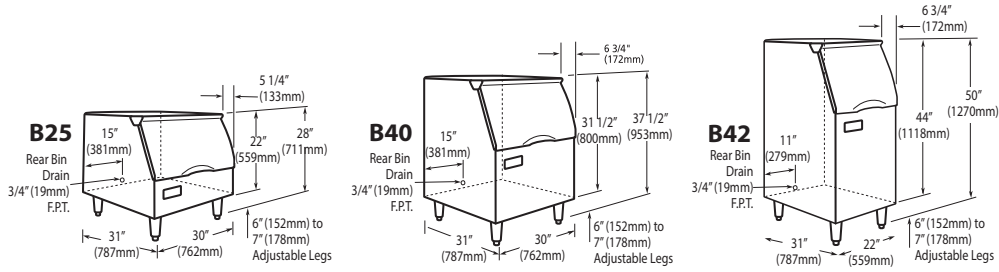

KBT5
Bin Top for 30" (762 mm) ICE series cuber including the ICE1506 family on a B100 bin

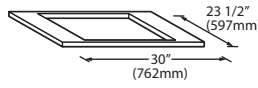

KBT19
Bin Top for 30" (762mm) bins with 22" (559mm) ICE Series Cube Ice Makers GEM Series Ice Makers & MFI Series Ice Makers

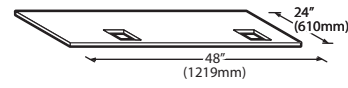

KBT22
Bin Top for 48" (1219mm) bins with (2) 21" (533mm) wide GEM Series Ice Makers & MFI Series Ice Makers

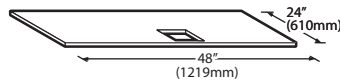

KBT23
Bin Top for 48" (1219mm) bins with (1) 21" (533mm) wide GEM Series Ice Makers & MFI Series Ice Makers

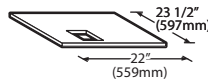

KBT24
Bin Top for 22" (559mm) bins with (1) 21" (533mm) wide GEM Series Ice Maker

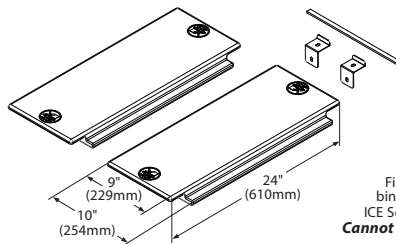

BPF-1
Filler Panel for B110 bins with 30" (762mm) ICE Series Cube Ice Makers
Cannot be used with the B100

NOTES:

Approx. Shipping Weight lbs (kg): B110 191 (87 kg) • B55 170 (77 kb) • B25 95 (43 kg) • B40 135 (61 kg) • B42 135 (61 kg)