



SUIM-210 ICE MACHINE

INCLUDE 2 YEAR PARTS + LABOR / 5 YEAR COMPRESSOR WARRANTY

Dimensions

Dimensions (WxDxH)	26" x 27" x 38.1"
Output (lb/24hr)	210 lbs
Bin Capacity	80 lbs
Net Weight	128 lbs
Gross Weight	146 lbs
Packaging Dimensions (WxDxH)	30.7" x 29.3" x 35.4"
Ice Cube Size half cube	.86"x.86".86"

Construction

Exterior Material	304 stainless steel
Interior Material	Polyethylene
Water Filter Capacity	2.2 GPM

Cooling

Refrigerant	R290
Temperature Display	Yes
Temperature Controller	Digital
Condenser Unit	Air
Compressor	Secop

Electrical

Voltage	115
Power	526W
Hz	60

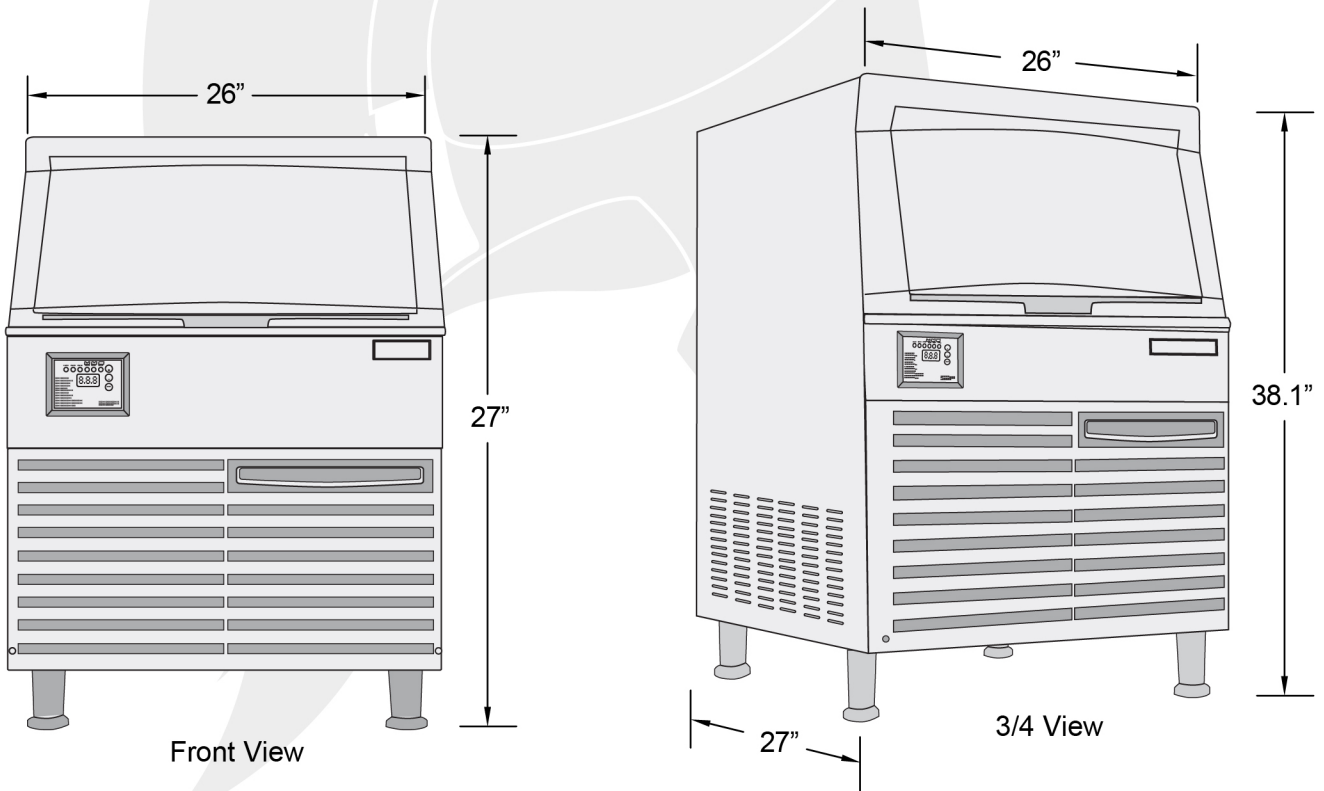

NEMA 5-15P



Intertek

