



Reach Ins

Installation, Operation and Maintenance Manual

**Please read this manual completely before attempting to install or operate this equipment.
Notify carrier of damage! Inspect all components immediately. See page 2.**



**IMPORTANT INFORMATION
READ BEFORE USE
PLEASE SAVE THESE INSTRUCTIONS!**

CONTENTS

RECEIVING & INSPECTING EQUIPMENT2

SPECIFICATIONS3

INSTALLATION4

OPERATION.....5

MAINTENANCE7

WIRING DIAGRAM9

All rights reserved. Reproduction without written permission is prohibited.

SERIAL NUMBER INFORMATION

The serial number of all self-contained refrigerators and freezers is located inside the unit on the left hand side near the top on the wall.

Always have the serial number of your unit available when calling for parts or service.

This manual covers standard units only. If you have a custom unit, consult the Technical Support Department at 1-888-275-4538; 514-737-9701.

RECEIVING AND INSPECTING THE EQUIPMENT

Even though most equipment is shipped crated, care should be taken during unloading so the equipment is not damaged while being moved into the building.

1. Visually inspect the exterior of the package and skid or container. Any damage should be noted on the delivery slip and reported to MVP Group immediately at 1-888-275-4538; 514-737-9701.
2. If damaged, open and inspect the contents with the carrier.
3. **WITHIN 48 HOURS OF RECEIPT:** In the event that the exterior is not damaged, yet upon opening, there is concealed damage to the equipment, notify MVP Group immediately at 1-888-275-4538; 514-737-9701.
4. Be certain to check the compressor compartment housing and visually inspect the refrigeration package. Be sure lines are secure and base is still intact.
5. Retain all crating material until an inspection has been made or waived.

SPECIFICATIONS

SOLID DOOR REFRIGERATORS

| MODEL# | V/Hz/Ph | AMPS | STORAGE CAPACITY Cu-ft | HP | SHELF CAPACITY Sq-ft | BTU | CHARGE OZ | SHIP WEIGHT LBS | NEMA PLUG |
|--------|----------|------|---------------------------|-----|-------------------------|------|--------------|--------------------|-----------|
| KB27R | 115/60/1 | 6 | 23 | 3/8 | 14.0 | 3200 | 12.0 | 350 | 5-15P |
| KB54R | 115/60/1 | 9 | 49 | 1/2 | 28.1 | 5800 | 18.7 | 518 | 5-15P |
| KB81R | 115/60/1 | 10 | 72 | 3/4 | 42.1 | 7625 | 21.2 | 669 | 5-15P |

GLASS DOOR REFRIGERATORS

| MODEL# | V/Hz/Ph | AMPS | STORAGE CAPACITY Cu-ft | HP | SHELF CAPACITY Sq-ft | BTU | CHARGE OZ | SHIP WEIGHT LBS | NEMA PLUG |
|--------|----------|------|---------------------------|-----|-------------------------|------|--------------|--------------------|-----------|
| KB27RG | 115/60/1 | 6 | 23 | 3/8 | 14.0 | 3200 | 12.0 | 350 | 5-15P |
| KB54RG | 115/60/1 | 9 | 49 | 1/2 | 28.1 | 5800 | 18.7 | 518 | 5-15P |

SOLID DOOR FREEZERS

| MODEL# | V/Hz/Ph | AMPS | STORAGE CAPACITY Cu-ft | HP | SHELF CAPACITY Sq-ft | BTU | CHARGE OZ | SHIP WEIGHT LBS | NEMA PLUG |
|--------|----------|------|---------------------------|-----|-------------------------|------|--------------|--------------------|-----------|
| KB27F | 115/60/1 | 11 | 23 | 5/8 | 14.0 | 2325 | 14.1 | 364 | 5-15P |
| KB54F | 115/60/1 | 12 | 49 | 1 | 28.1 | 3650 | 25 | 568 | 5-15P |

SOLID DOOR FREEZERS

| MODEL# | V/Hz/Ph | AMPS | STORAGE CAPACITY Cu-ft | HP | SHELF CAPACITY Sq-ft | BTU | CHARGE OZ | SHIP WEIGHT LBS | NEMA PLUG |
|---------|----------------------|------|---------------------------|-------|-------------------------|------|--------------|--------------------|-----------|
| KB81FDV | 115/208~ 230/60/1 | 16 | 72 | 1-1/4 | 42.1 | 4500 | 28.9 | 776 | L14-20P |

INSTALLATION

Location

Units represented in this manual are intended for indoor use only. Be sure the location chosen has a floor strong enough to support the total weight of the cabinet and contents. A fully loaded unit can weigh as much as 1500 pounds. Reinforce the floor as necessary to provide for maximum loading. For the most efficient refrigeration, be sure to provide good air circulation inside and out.

Inside Cabinet

Do not pack the units so full that air cannot circulate. The refrigerated air is discharged at the top rear of the unit. It is important to allow for proper air flow from the top rear to the bottom of the unit. Obstructions to this air flow can cause evaporator coil freeze ups and loss of temperature or overflow of water from the evaporator drain pan. The shelves have a rear turn up on them to prevent this. However, bags and other items can still be located to the far rear of the cabinet. Air is brought into the evaporator coil with fans. Prevent any obstruction from blocking the outlet or inlet of air flow.

Outside Cabinet

Be sure that the unit has adequate air circulation around it. Avoid hot corners and locations near stoves and ovens.

It is recommended that the unit be installed no closer than 2" from any wall with at least 12" of clear space above the unit.

Leveling

Leveling the cabinet is necessary so that the doors will line up with the frames properly. Use a level to make sure the unit is level from front to back and side to side. Units supplied with legs will have adjustable bullet feet to make the necessary adjustments. If the unit is supplied with casters, no adjustments are available. Ensure the floor where the unit is to be located is level.

Stabilizing

All models are supplied with casters for your convenience. It is very important, however, that the cabinet be installed in a stable condition with the front wheels locked while in use.

Should it become necessary to lay the unit on its side or back for any reason, allow at least 24 hours before start-up to allow compressor oil to flow back to place. Failure to meet this requirement can cause compressor failure and unit damage.



NOTE

Warranty Repairs will be declined if problems are caused by improper installation.

Electrical Connection

Refer to the amperage data on page 3, the serial tag, your local code or the National Electrical Code to be sure the unit is connected to the proper power source. Each unit must be plugged on a dedicated electric circuit.. Do not use an extension cord. An external electrical surge protector may be required. (not included)



DANGER

The unit must be turned OFF and disconnected from the power source whenever performing service, maintenance functions or cleaning the refrigerated area.

OPERATION



CAUTION

Do not throw items into the storage area. Failure to heed these recommendations could result in damage to the interior of the cabinet.

Refrigerated cycle

Refrigerators: During the refrigeration cycle, the evaporator fans will run continuously even when one or more doors are open. The door switch will activate the lights when opened.

1. Every 6 hours, the unit will turn off and to allow the evaporator coil to defrost. The controller now displays defrost symbol. When the coil temperature reaches 41°F or after 20 minutes of defrost, the unit will turn on again.
2. Anti-condensation heaters on door frames work in conjunction with the compressor.
3. The factory setting for the temperature range is 34°F to 38°F.

Freezers: During the refrigeration cycle, the controller supplies power to the condensing unit and evaporator fan motors. The evaporator fans will run at any time when the evaporator coil temperature is below 54° F. They will also keep running when door is open but cycle off during a defrost period. The door switch will activate the lights when opened.

1. Every 6 hours, the unit will turn off and electric heater will turn on to defrost. The controller now displays the defrost symbol. When the coil temperature reaches 45°F or after 20 minutes of defrost, the unit will turn on again.
2. Anti-condensation heaters on door frames work in conjunction with the compressor.
3. The factory setting for temperature range is -7°F to -3°F

SOLID-STATE THERMOSTAT DESCRIPTIONS

1. FRONT PANEL COMMANDS





SET: To display target set point; in programming mode it selects a parameter or confirm an operation.

 **(DEF)** To start a manual defrost

 **(UP)** To view the last alarm occurrence; in programming mode it browses the parameter codes or increases the display value

 **(DOWN)** To view the last alarm occurrence; in programming mode it browses the parameter codes or decreases the display value









KEY COMBINATION

 +  To lock & unlock the keyboard

SET +  To enter in programming mode

SET +  To return to the room temperature display

1.1 Function of LEDS

| LED | MODE | FUNCTION |
|---|----------|---|
|  | ON | Compressor enabled |
|  | Flashing | -Programming Phase (flashing with ) - Anti-short cycle delay enabled |
|  | ON | Defrost enabled |
|  | Flashing | - Programming Phase (flashing with ) - Drip time in progress |
|  | ON | Fans enabled |
|  | Flashing | Fans delay after defrost in progress. |
|  | ON | An temperature alarm happened |



2. MAIN FUNCTIONS

2.1 HOW TO SEE THE SETPOINT

1. Push and immediately release the **SET** key: the display will show the set point value.
2. Push and immediately release the **SET** key or wait for 5 seconds to display the sensor value again.



2.2 HOW TO CHANGE THE SETPOINT



1. Hold the **SET** key for more than 2 seconds to change the set point value.
2. The value of the set point will be displayed and the  LED starts blinking.
3. To change the set value, push the  or  key within 10s.
4. To set new point value, push the SET key again or wait 10s.

2.3 HOW TO START A MANUAL DEFFROST

Hold the  key for more than 2 seconds and a manual defrost will start





2.4 HOW TO LOCK THE KEYBOARD

1. Hold the  and  keys for more than 3s.
2. The **POF** message will be displayed and the keyboard will be locked. At this point, it will be possible only to see the set point or the MAX or Min temperature stored.
3. If a key is pressed more than 3s the **POF** message will be displayed.





2.5 HOW TO UNLOCK THE KEYBOARD

Hold the  and  keys together for more than 3s until the **POF** message is displayed.

3. ALARM SIGNALS

HOW TO SEE THE ALARM AND RESET THE RECORDED ALARM

1. Push the  or  key to display the alarm signals.
2. When the signal is displayed, hold the **SET** key until the **fst** message is displayed, and push the **SET** key again. The **fst** message starts blinking and the normal temperature will be displayed.

| Message | Cause | Outputs |
|---------|----------------------------------|---|
| "P1" | Room probe failure | Compressor output according to par. "Con" and "COF" |
| "P2" | Evaporator probe failure | Defrost end is timed |
| "HA" | Maximum temperature alarm | Outputs unchanged. |
| "LA" | Minimum temperature alarm | Outputs unchanged. |
| "dA" | Door open | Compressor and fans restarts |
| "EA" | External alarm | Output unchanged. |
| "CA" | Serious external alarm (i1F=bAL) | All outputs OFF. |
| "CA" | Pressure switch alarm (i1F=PAL) | All outputs OFF |

MAINTENANCE



The unit must be turned OFF and disconnected from the power source whenever performing service, maintenance functions or cleaning the refrigerated area.

Refrigerators and Freezers

The interior and exterior can be cleaned using soap and warm water. If this isn't sufficient, try ammonia and water or a nonabrasive liquid cleaner. When cleaning the exterior, always rub with the "grain" of the stainless steel to avoid marring the finish.

Do not use an abrasive cleaner because it will scratch the stainless steel and plastic and can damage the breaker strips and gaskets.

Cleaning the Condenser Coil

The condenser coil requires regular cleaning and it is recommended every 90 days. In some instances, you may find that there is a large amount of debris and dust or grease accumulated prior to the 90 day time frame. In these cases the condenser coil should be cleaned every 30 days.

If the build up on the coil consists of only light dust and debris, the condenser coil can be cleaned with a simple brush. Heavier dust build-up may require a vacuum or even compressed air to blow through the condenser coil.

If heavy grease is present, there are de-greasing agents available for refrigeration use and specifically for the condenser coils. The condenser coil may require cleaning with the de-greasing agent and then blown through with compressed air.

Failure to maintain a clean condenser coil can initially cause high temperatures and excessive run times. Continuous operation with dirty or clogged condenser coils can result in compressor failures. Neglecting the condenser coil cleaning procedures will void any warranties associated with the compressor or cost to replace the compressor.



Never use a high pressure water wash for this cleaning procedure as water can damage the electrical components located near or at the condenser coil.

In order to maintain proper refrigeration performance, the condenser fins must be cleaned of dust, dirt and grease regularly. It is recommended that this be done at least every three months. If conditions are such that the condenser is totally blocked in three months, the frequency of cleaning should be increased. Clean the condenser with a vacuum cleaner or stiff brush. If extremely dirty, a commercial-grade condenser cleaner may be required.

Stainless Steel Care and Cleaning

To prevent discoloration of rust on stainless steel several important steps need to be taken. First, we need to understand the properties of stainless steel. Stainless steel contains 70-80% iron which will rust. It also contains 12-30% chromium which forms an invisible passive film over the steels surface which acts as a shield against corrosion. As long as the protective layer is intact, the metal is still stainless. If the film is broken or contaminated, outside elements can begin to breakdown the steel and begin to form rust or discoloration.

Proper cleaning of stainless steel requires soft cloths or plastic scouring pads,



NEVER USE STEEL PADS, WIRE BRUSHES OR SCRAPERS!

MAINTENANCE

Cleaning solutions need to be alkaline based or non-chloride based. Any cleaner containing chlorides will damage the protective film of the stainless steel. Chlorides are commonly found in hard water, salts, and household and industrial cleaners. If cleaners containing chlorides are used, be sure to rinse and dry thoroughly.

Routine cleaning of stainless steel can be done with soap and water. Extreme stains or grease should be cleaned with a non-abrasive cleaner and plastic scrub pad. It is always good to rub with the grain of the steel. There are also stainless steel cleaners available which can restore and preserve the finish of the steel's protective layer.

Early signs of stainless steel breakdown can consist of small pits and cracks. If this has begun, clean thoroughly and start to apply stainless steel cleaners in attempt to restore the passivity of the steel.



CAUTION

Never use an acid based cleaning solution ! Many food products have an acidic content which can deteriorate the finish. Be sure to clean the stainless steel surfaces of ALL food products.

Gasket Maintenance

Gaskets require regular cleaning to prevent mold and mildew build up and also to keep the elasticity of the gasket. Gasket cleaning can be done with the use of warm soapy water. Avoid full strength cleaning products on gaskets as this can cause them to become brittle and prevent proper seals. Do not use sharp tools or knives to scrape or clean the gasket which could possibly tear the gasket and rip the bellows.

Gaskets can easily be replaced and don't require the use of tools or authorized service technicians. The gaskets are "Dart" style and can be pulled out of the groove in the door and replaced by pressing the new one back into place.

Doors/Hinges

Over time and with heavy use, door hinges may become loose. If the door is beginning to sag, tighten the screws that mount the hinge brackets to the frame of the unit. If the doors are loose or sagging, this can cause the hinge to pull out of the frame which may damage both the doors and the door hinges.

Drain Maintenance

Each unit has a drain located inside the unit which removes the condensation from the evaporator coil and evaporates it into an external condensate evaporator pan. Each drain can become loose or disconnected from moving or bumping the drain. If you notice excessive water accumulation on the inside of the unit, be sure the drain tube is connected from the evaporator housing to the condensate evaporator drain pan. If water starts to collect underneath the unit, you may want to check the condensate evaporator drain tube to be sure it is still located inside the drain pan. The leveling of the unit is important as the units are designed to drain properly when on a level surface, if your floor is not level, this can also cause drain problems. Be sure all drain lines are free of obstructions because this may cause water to back up and overflow the drain pans.

ELECTRICAL DIAGRAM

MODEL: KB27R

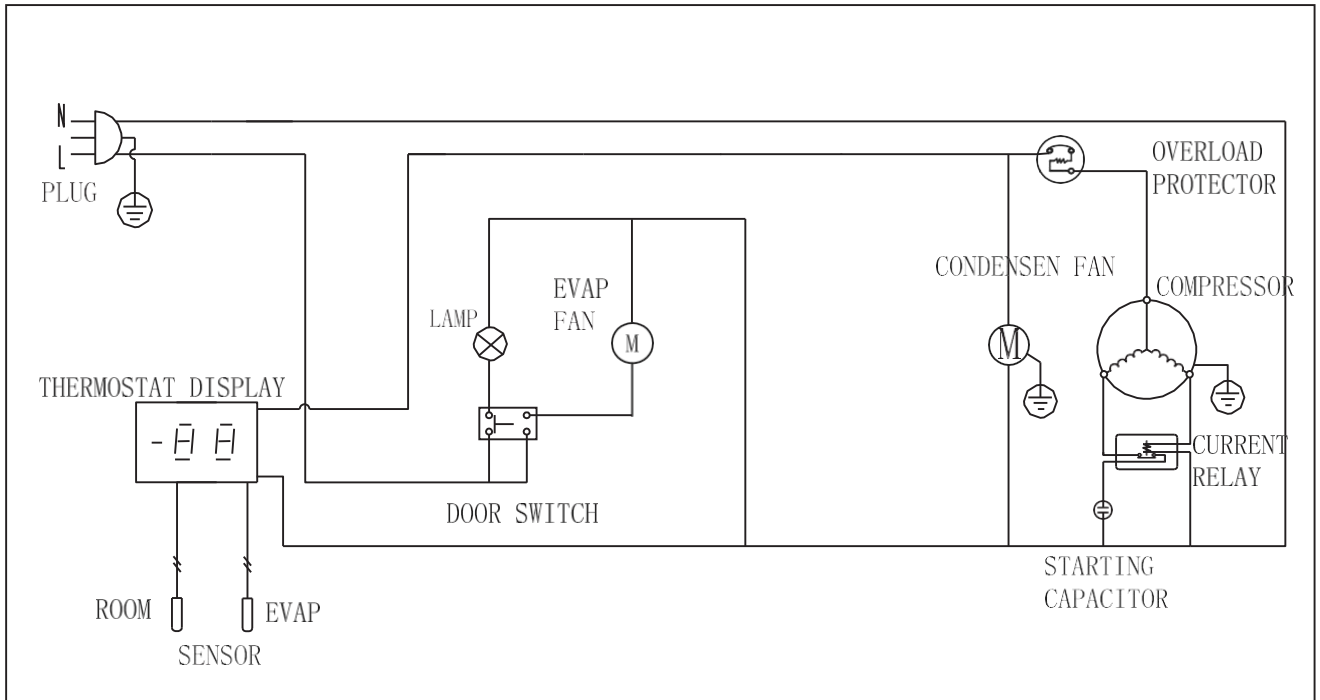

MODEL: KB54R

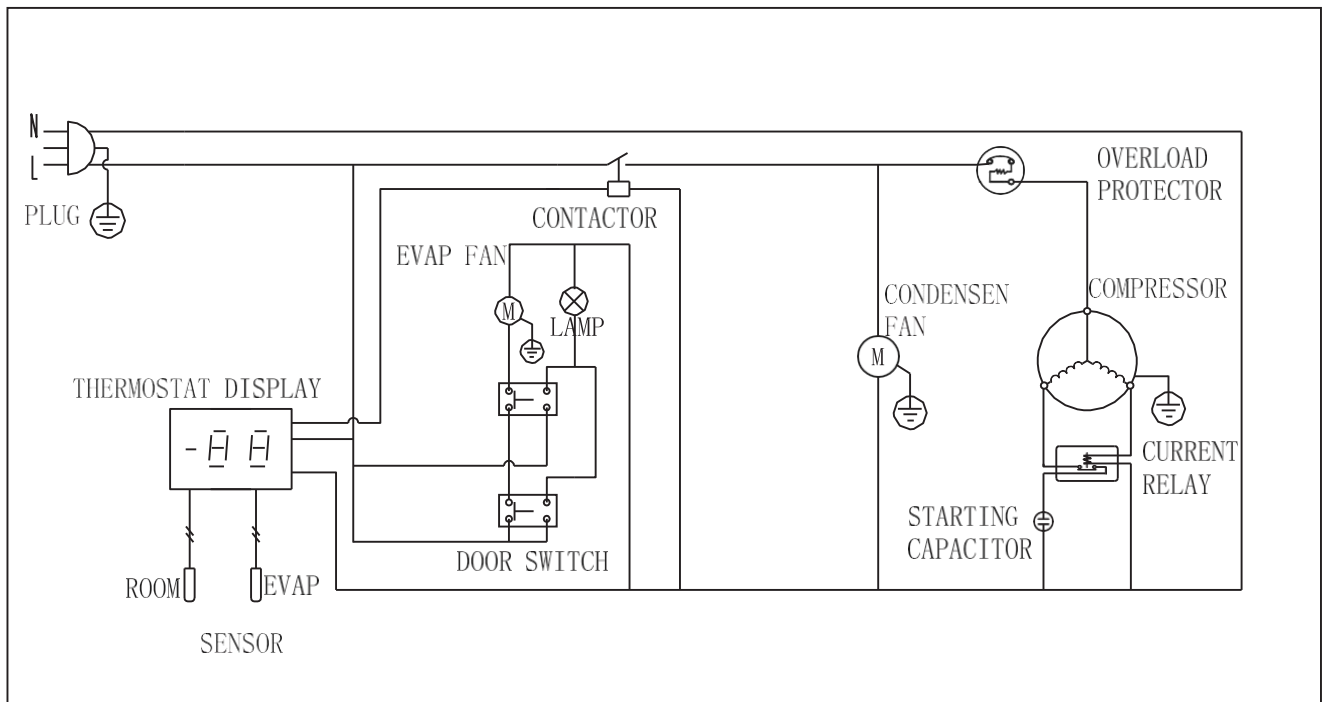

ELECTRICAL DIAGRAM

MODEL: KB81R

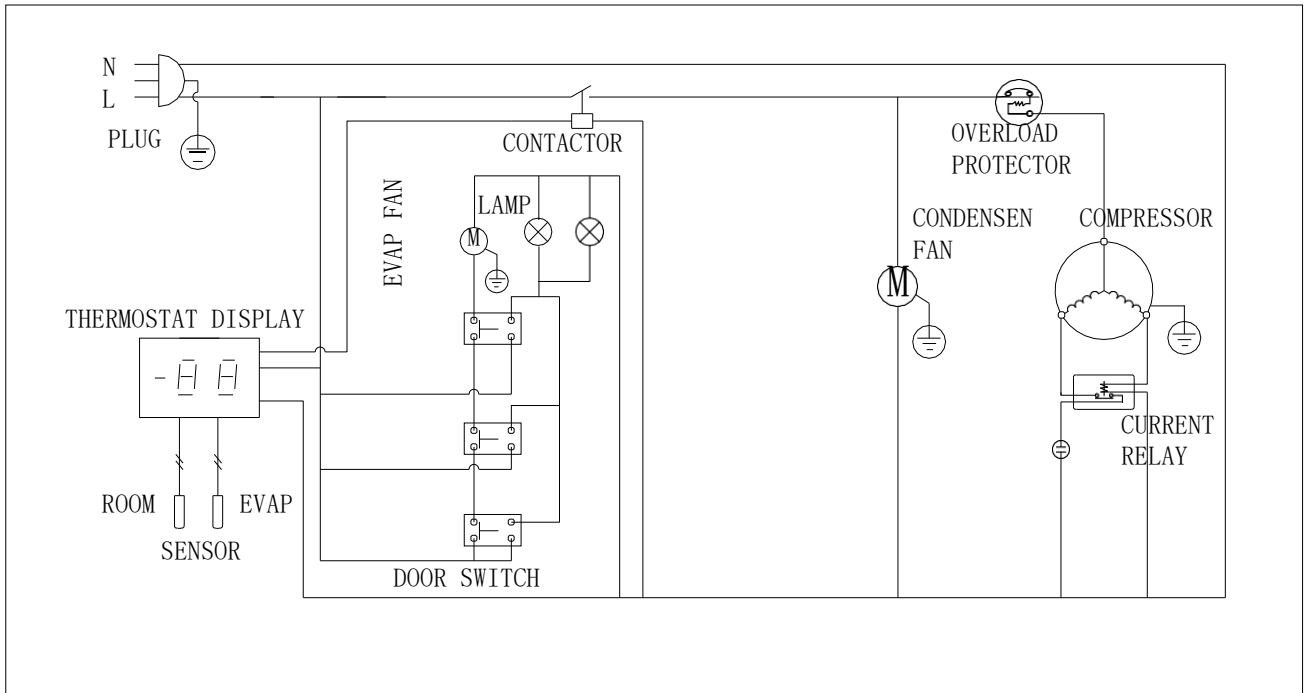

MODEL: KB27RG

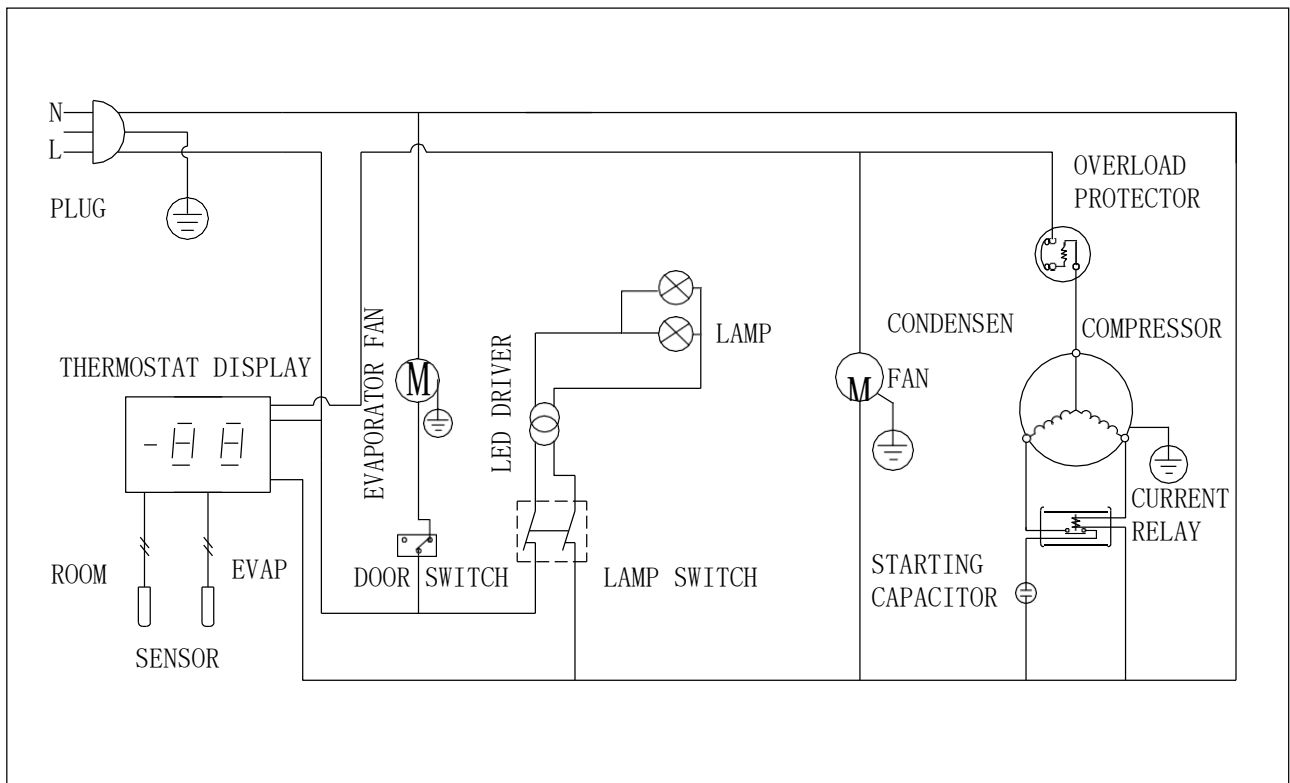

ELECTRICAL DIAGRAM

MODEL: KB54RG

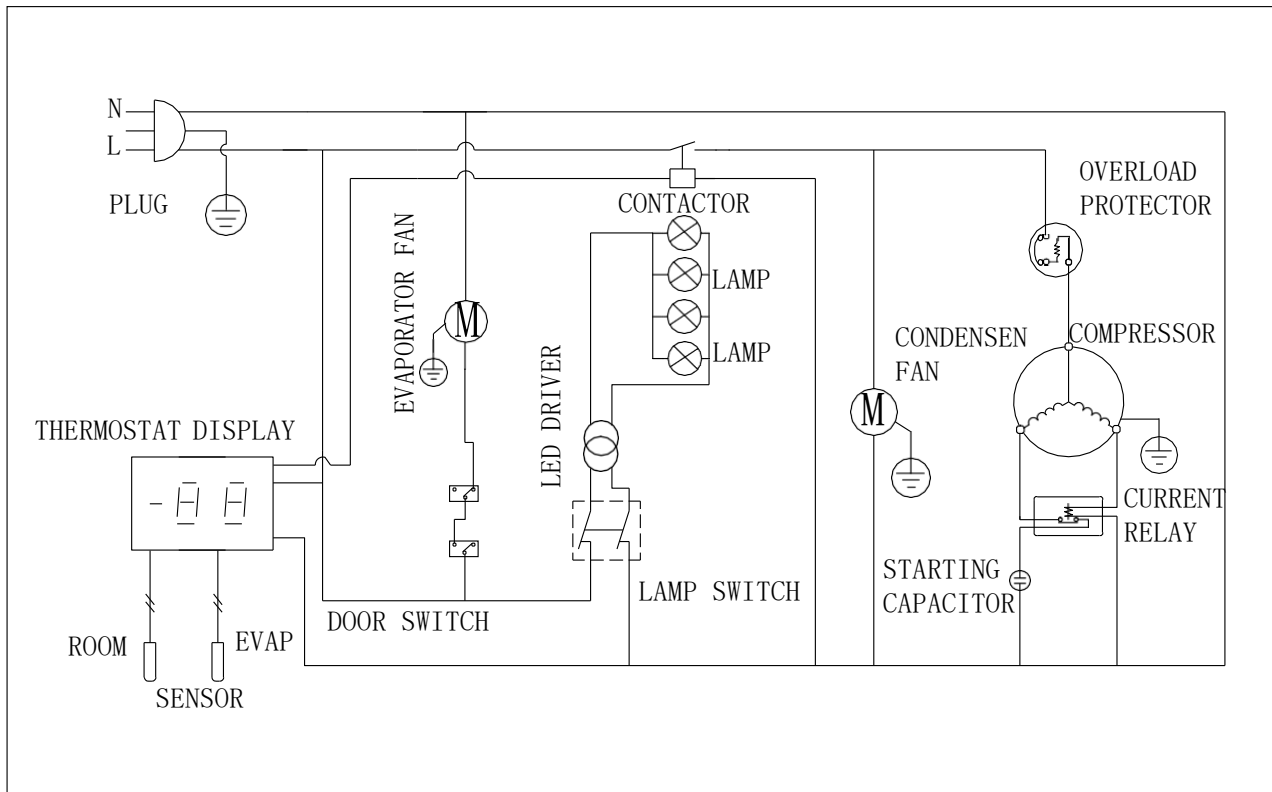

MODEL: KB27F

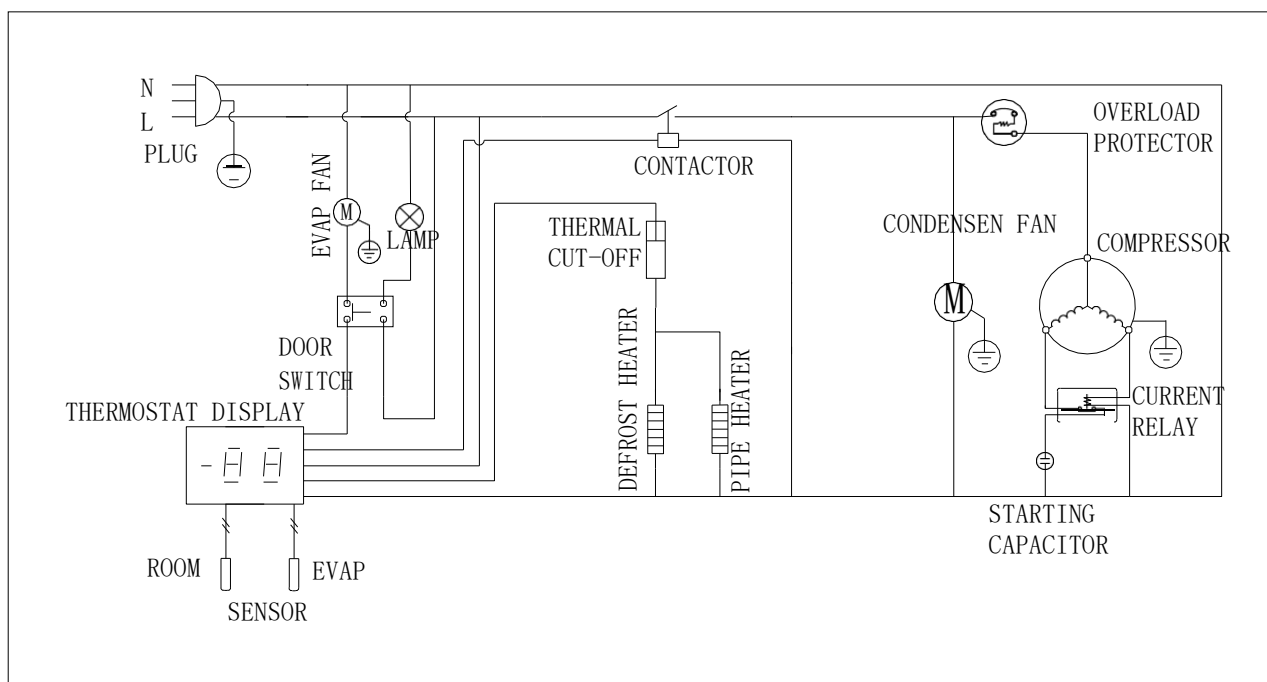

ELECTRICAL DIAGRAM

MODEL: KB54F

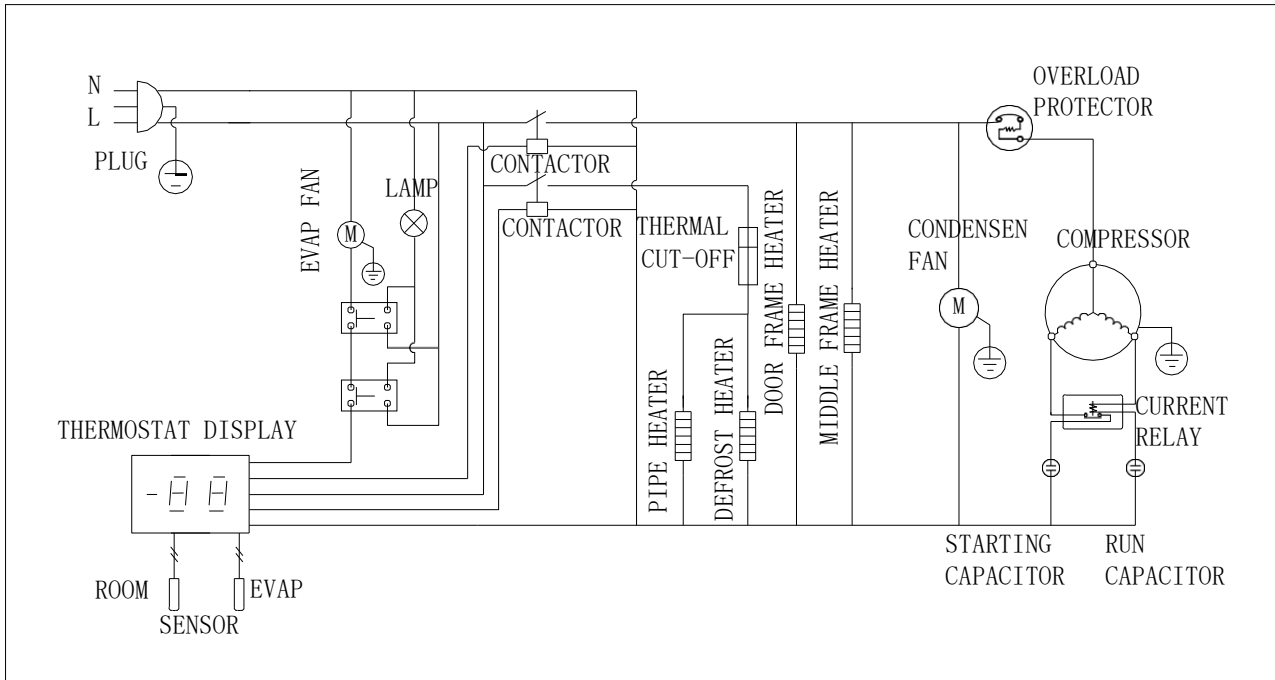

MODEL: KB81FDV

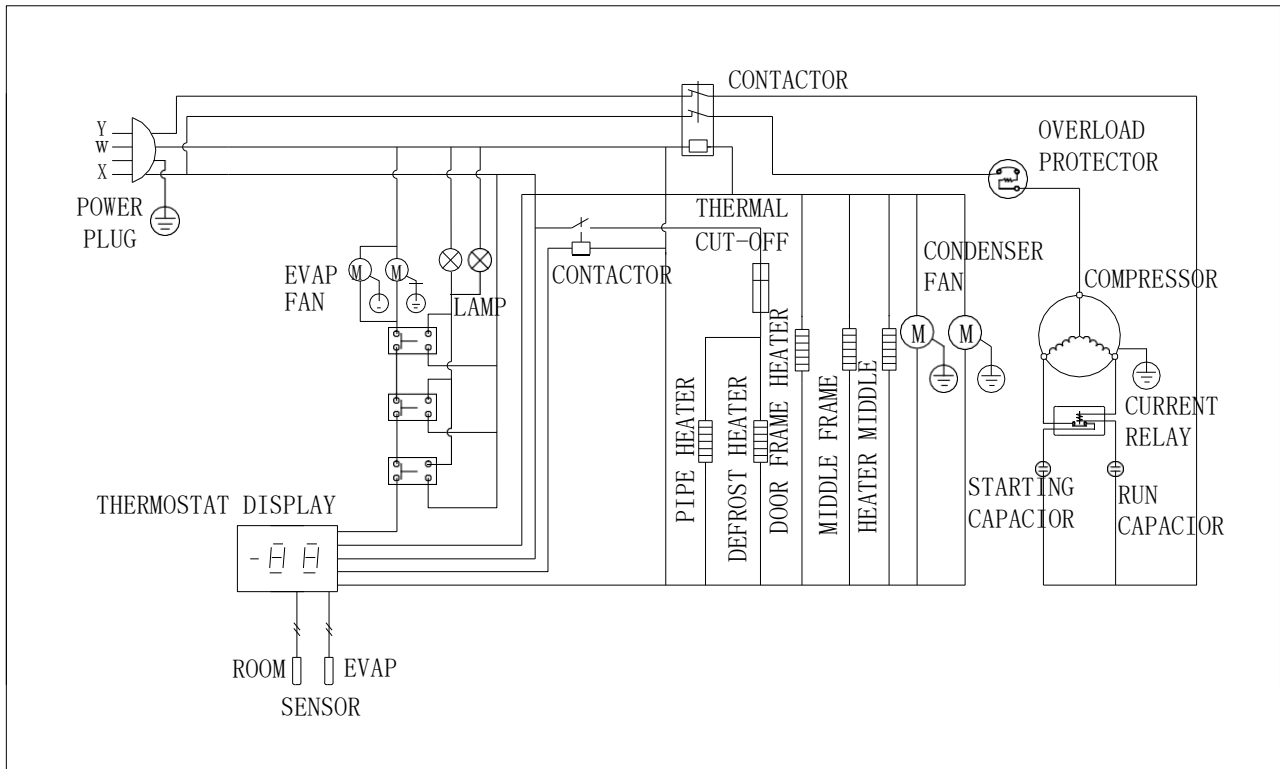

WIRING DIAGRAM

MODEL: KB27R

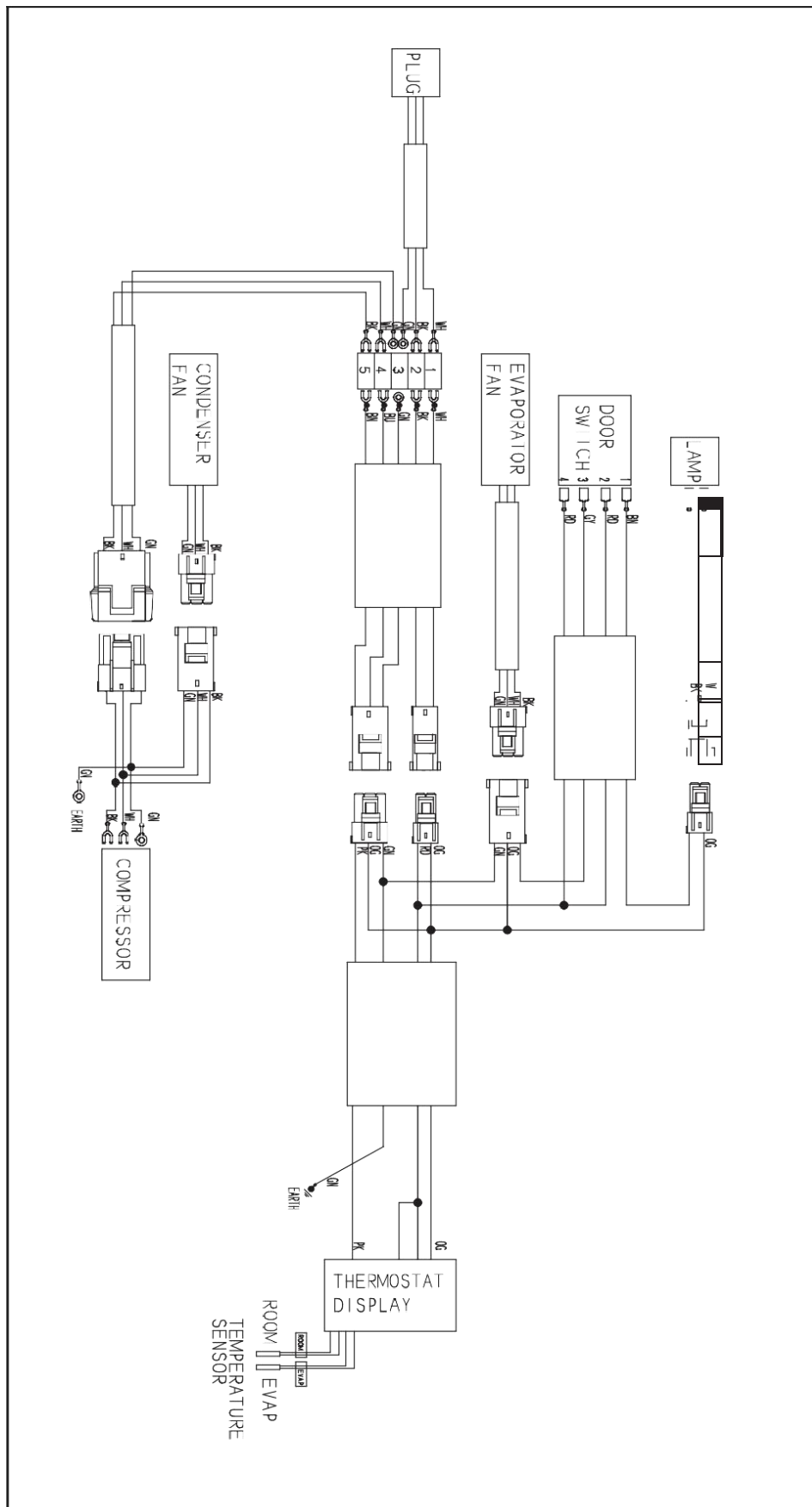

WIRING DIAGRAM

MODEL: KB27RG

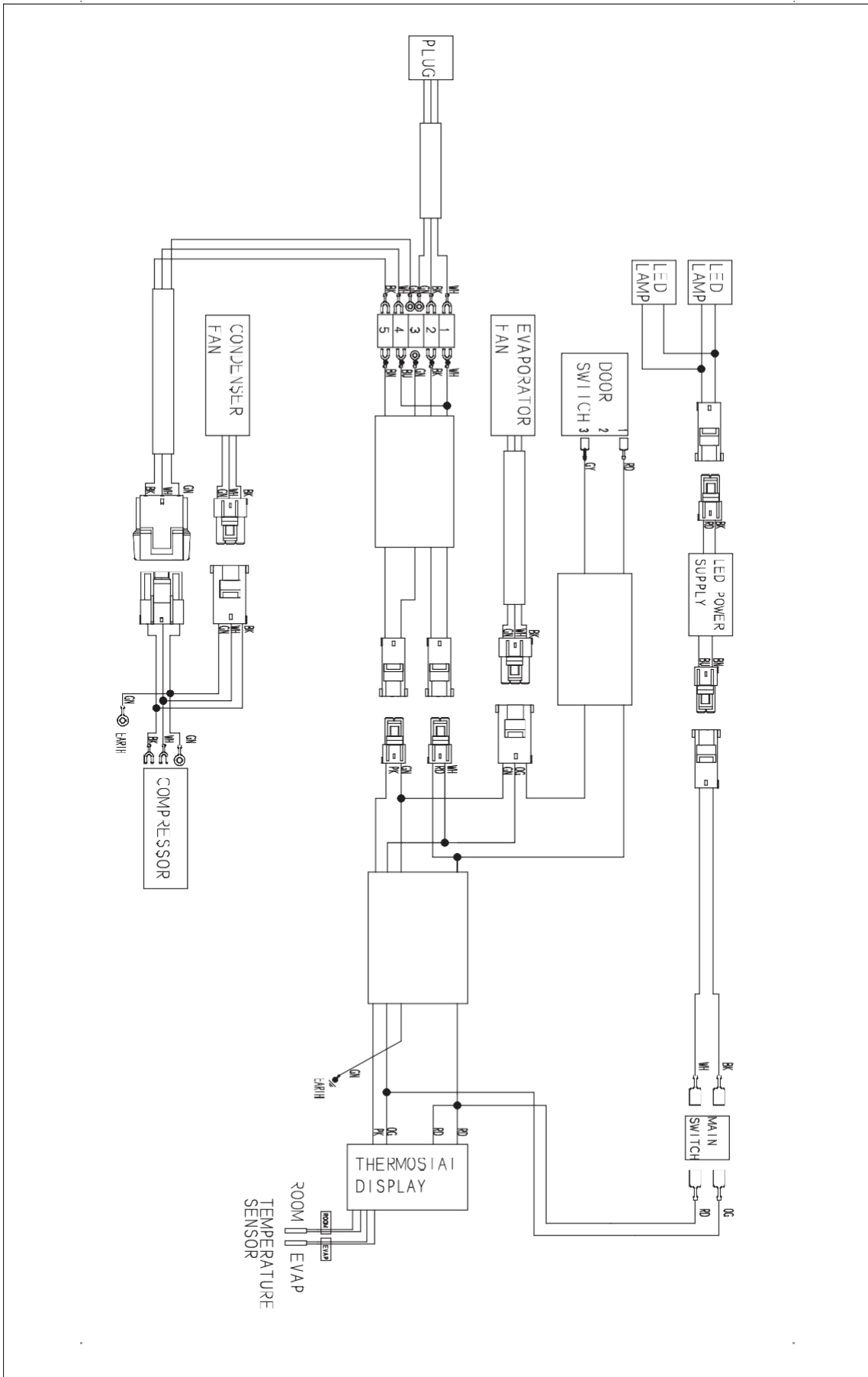

WIRING DIAGRAM

MODEL: KB27F

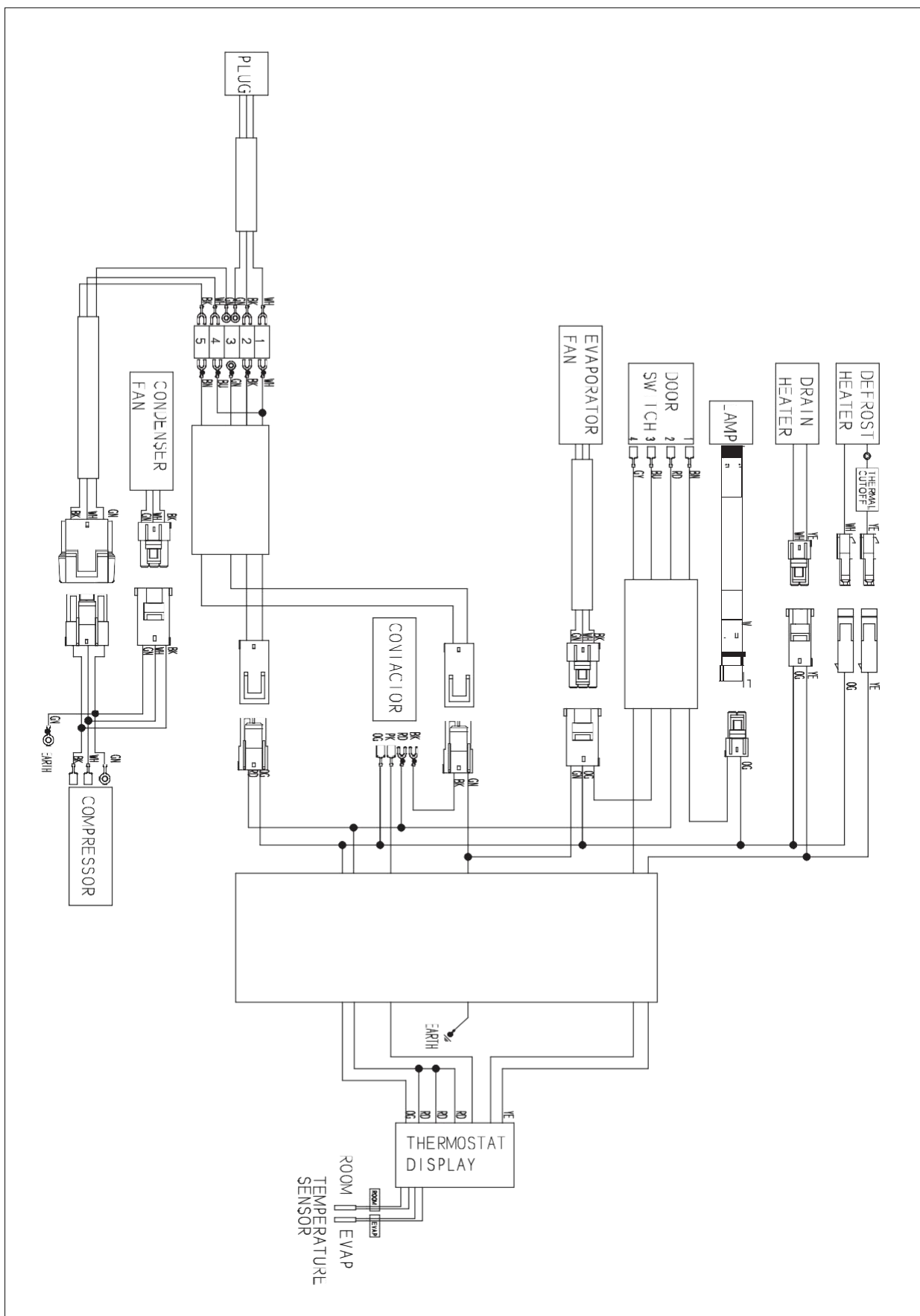

WIRING DIAGRAM

MODEL: KB54R

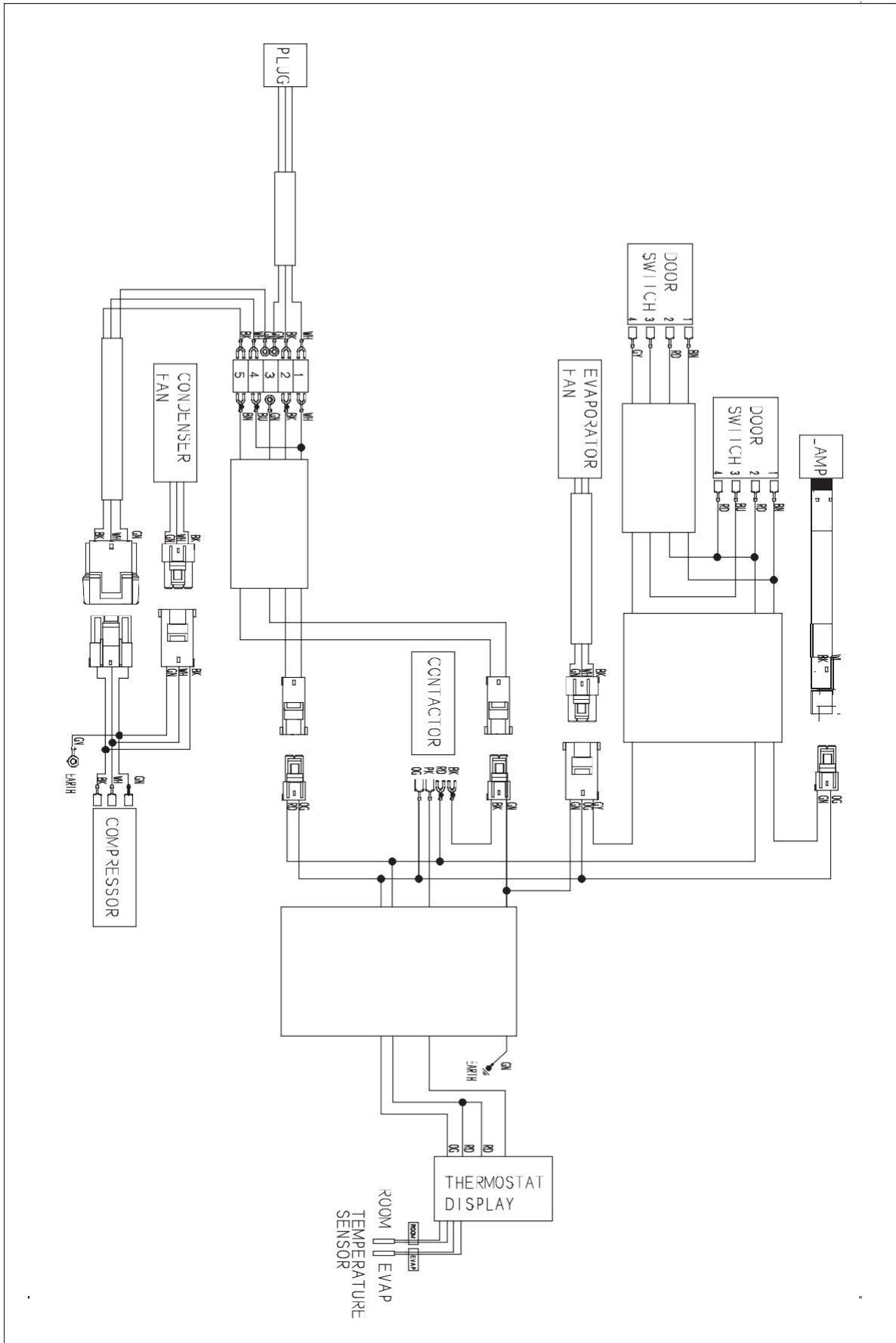

WIRING DIAGRAM

MODEL: KB54F

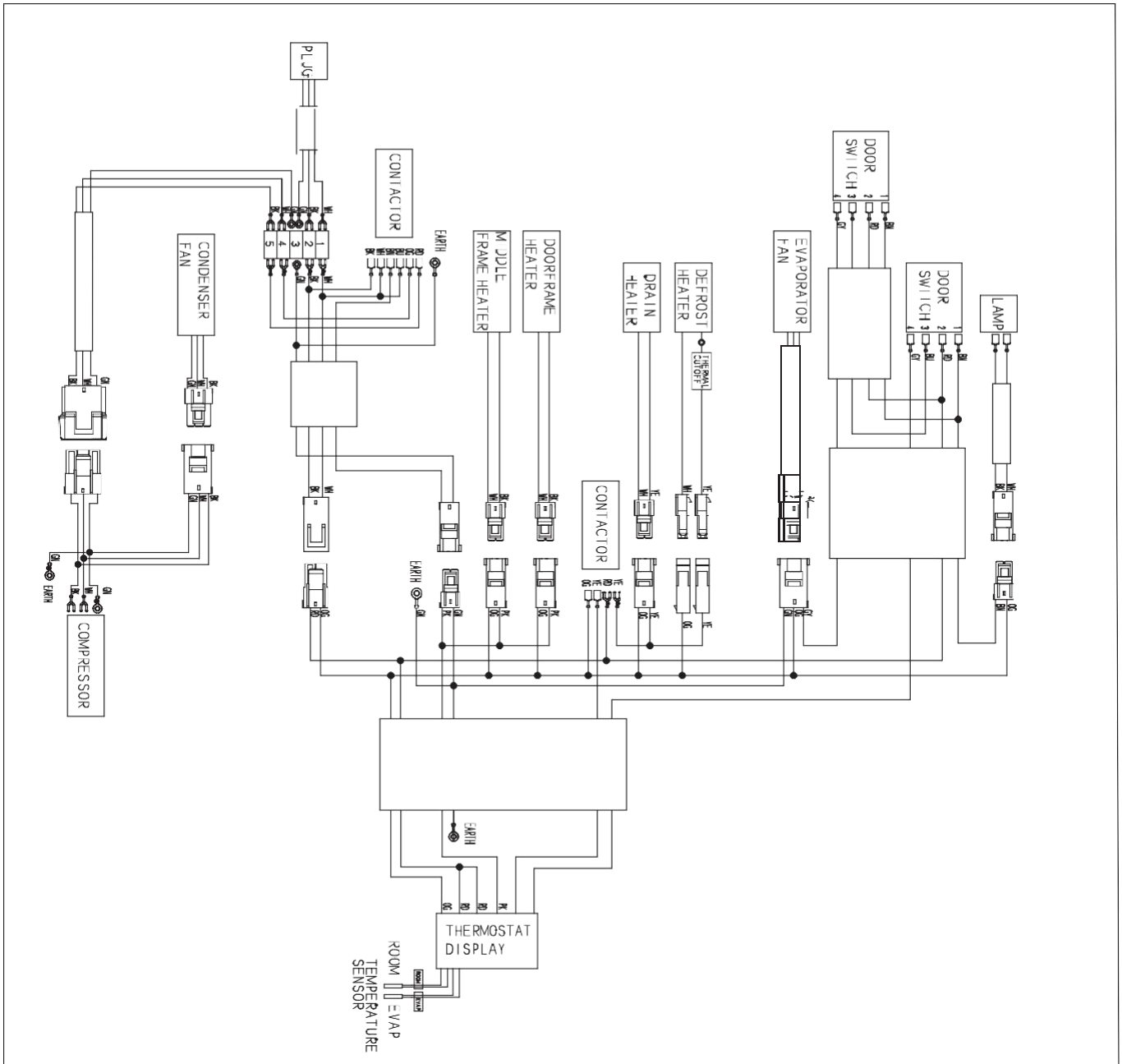

WIRING DIAGRAM

MODEL: KB81R

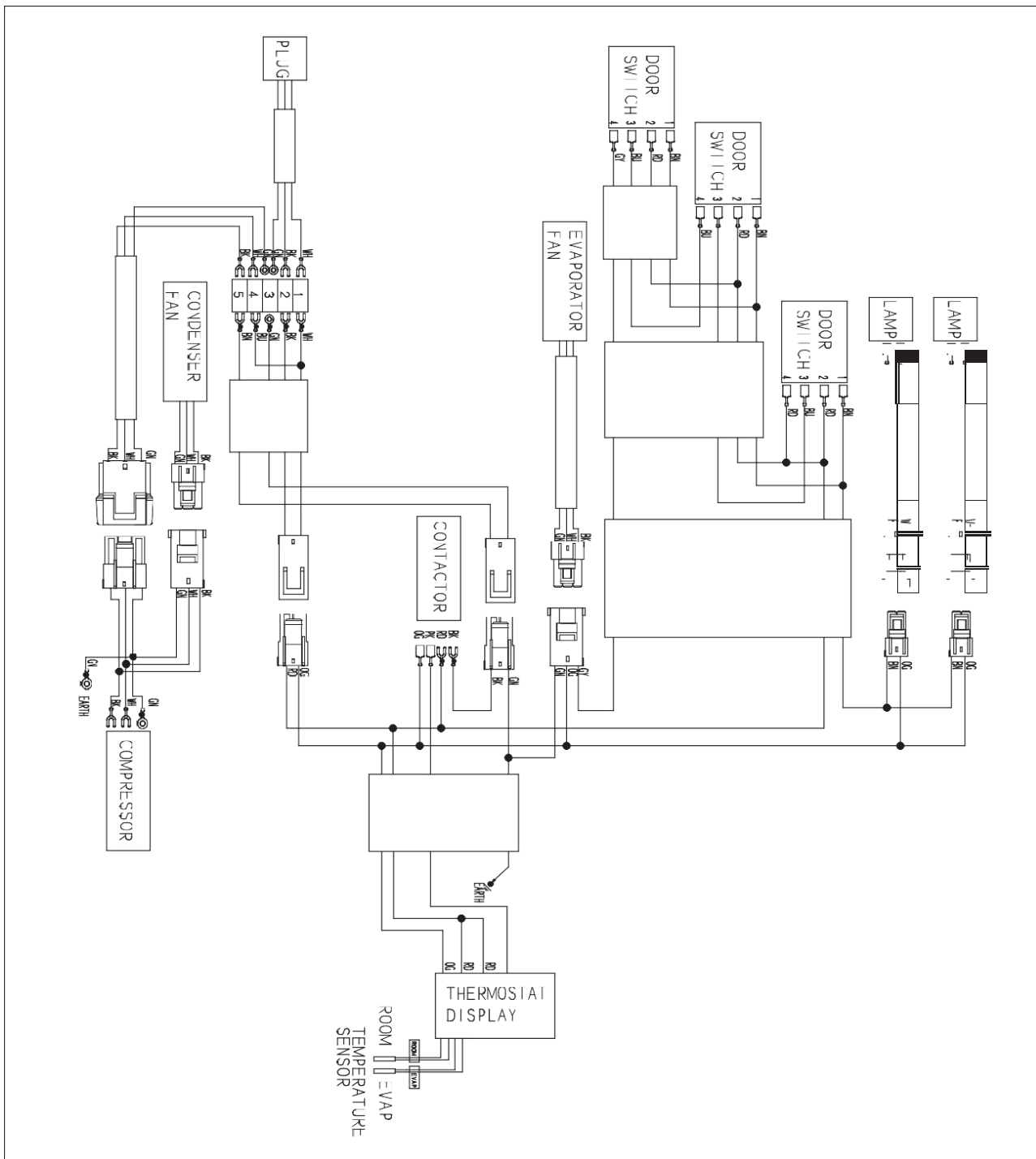

WIRING DIAGRAM

MODEL: KB81FDV

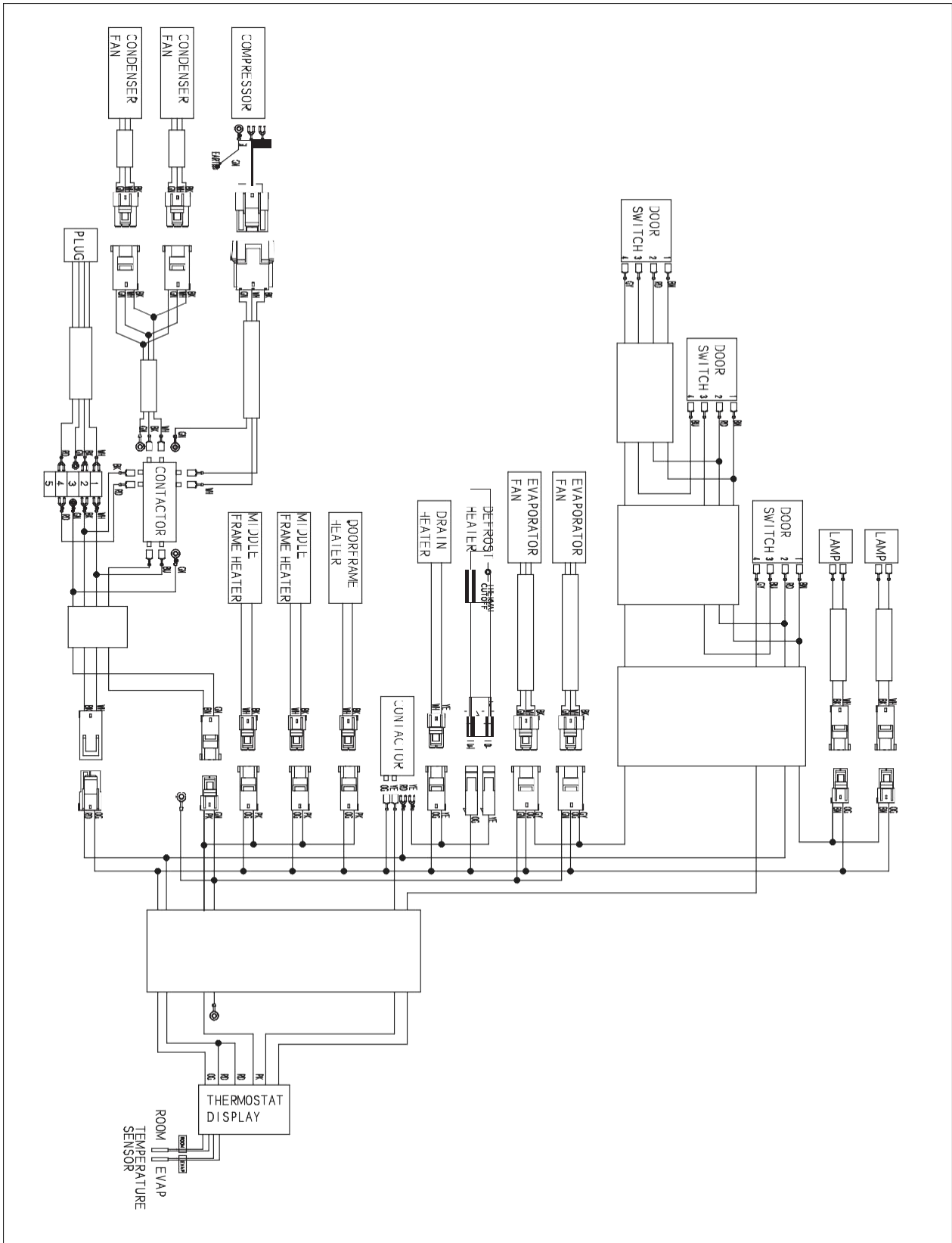

IKON WARRANTY

Two Year Parts & Labor Warranty

MVP Group (IKON) warrants, to the original purchaser, all of its new equipment to be free from defects in material and workmanship, under normal use and maintenance service, for a period of two (2) years from the date of original purchase or 15 months after shipment date from the manufacturer, whichever occurs first. Warranty coverage is limited to the repair and/or replacement, including labor charges, of defective parts and/or assemblies. The labor warranty shall include straight time labor charges and travel charges within 100 miles roundtrip. Warranty service must be arranged by calling **514 737-9701**, or toll free, **1 888 275-4538** for service in the United States and Canada. Warranty service coverage is not offered outside of the United States and Canada.

Additional Three Year Compressor Warranty

In addition to the two (2) years warranty stated above, IKON warrants its compressor units to be free from defects in both material and installation workmanship under normal and proper use and maintenance service for a period of three (3) additional years from the date of original installation but not to exceed five (5) years and three (3) months after shipment from IKON. The three (3) year extended compressor warranty applies only to the compressor part itself and does not apply to other parts, components or labor charges involved in replacement of compressor.

*RESIDENTIAL APPLICATIONS: MVP GROUP CORP. assumes no responsibility nor liability for any parts, or labor coverage for component failure, or other damage resulting from installation in residential or non-commercial applications.

Conditions

All service under this warranty, for either labor or parts, must be performed by a preferred service provider arranged by the IKON Warranty Department at **514 737-9701**, or toll free, **1 888 275-4538**. Warranty claims should include model number of the unit, batch & serial number of the unit, and proof of purchase. Service coverage is limited to units located in the United States and Canada only.

Limitation & Exclusive Warranty

This part and labor warranty is the sole and exclusive warranty remedy offered by IKON. IKON's sole obligation under this warranty is limited to either repair or replacement of parts and is subject to the limitations listed below.

1. IKON will bear no responsibility or liability for any equipment which has been misapplied, mishandled, misused, subjected to harsh chemical action, or external causes such as the use of extension cords, electrical power fluctuation, lack of proper maintenance, non-factory approved revisions or modifications or equipment damaged by fire, flood, or other acts of God.
2. IKON will bear no responsibility for consequential loss or damages such as, including but not limited to, economic loss, profit loss, personal injury, property damage, damage during transit, losses or damages arising from food or product spoilage claims.
3. IKON shall bear no responsibility for parts or labor coverage for component failure or other damages resulting from improper usage, installation, or maintenance as described in the owner's manual.
4. Exceptions to two (2) year part warranty other than additional three (3) year compressor warranty. Light bulbs and door gaskets are limited to 90 warranty period, parts only.
5. IKON equipment is intended for commercial use only and this warranty is void if the equipment is installed in other than commercial applications. IKON assumes no responsibility nor liability for any parts, or labor coverage for component failure, or other damage resulting from installation in residential or non-commercial applications.
6. All other warranties, either express or implied arising under law or equity or custom of the trade, including but not limited to, warranties or merchantability or fitness for a particular purpose are excluded. IKON's liability on any claim, including but not limited to negligence, shall not exceed the price of the equipment that gives rise to the claim.